

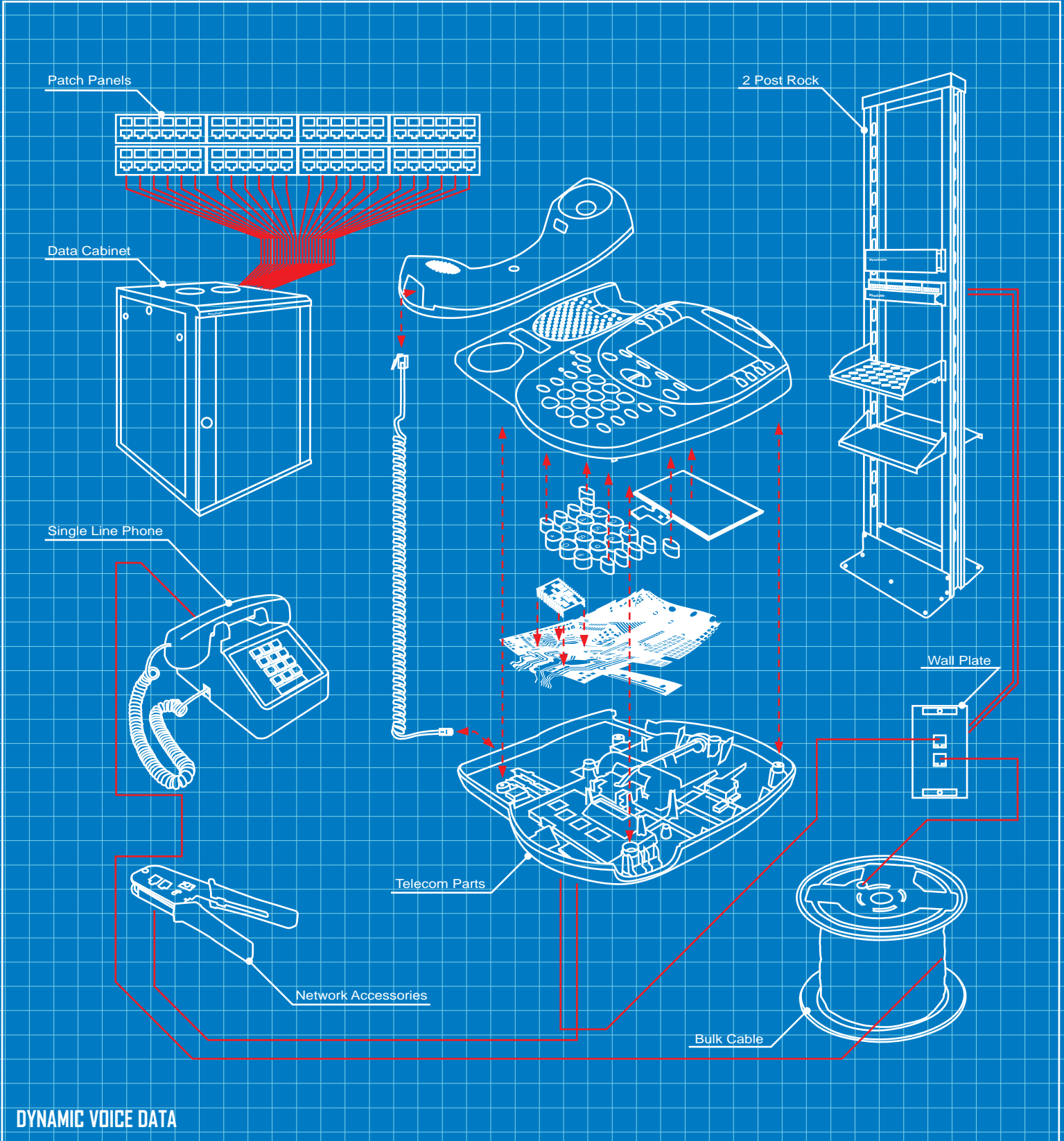

DYNAMIC VOICE DATA

Version. 23

Your #1 Innovative Solutions Manufacturer Since 1993
Telecom Refurbish & Repair and Data Network Products at their Best



Contents

If we don't have it, please give us an opportunity to find it for you.

01 NETWORK
CONNECTIVITY

11 SPECTRALINK

14 CISCO

19 NORTEL

35 AT&T AVAYA

54 NEC

60 PANASONIC

61 TOSHIBA

63 INTER-TEL

64 EXECUTONE

65 SAMSUNG

66 COMDIAL

66 FUJITSU

66 VODAVI

67 TIE

67 IWATSU

67 NITSUKO

67 SHORTEL

68 ROLM

68 PROSTAR

68 MITEL

68 PHONE CORDS

69 POLYCOM

TELEPHONE



231501-
2554 Mini Wall Phone With Volume Control
Available Colors: **01 02**



231501-
2554 Mini Wall Phone, Message Waiting Light
Available Colors: **01 02**
Order To Make



211501-
2500 Telephone With Data Port, Message Waiting Light
Available Colors: **01**
Order To Make



221501-
2500 Single Phone with Volume Control
Available Colors: **01 02**
Order To Make

CAT5E PATCH CORDS

Red Snagless Cable

24AWG
UTP 350MHz
UL LISTED: E467035
1ft: NWPC5SRD01
2ft: NWPC5SRD02
3ft: NWPC5SRD03
5ft: NWPC5SRD05
7ft: NWPC5SRD07
10ft: NWPC5SRD10
14ft: NWPC5SRD14
25ft: NWPC5SRD25
50ft: NWPC5SRD50



Orange Snagless Cable

24AWG
UTP 350MHz
UL LISTED: E467035
1ft: NWPC5SOR01
3ft: NWPC5SOR03
5ft: NWPC5SOR05
25ft: NWPC5SOR25



Yellow Snagless Cable

24AWG
UTP 350MHz
UL LISTED: E467035
1ft: NWPC5SYW01
2ft: NWPC5SYW02
3ft: NWPC5SYW03
5ft: NWPC5SYW05
7ft: NWPC5SYW07
10ft: NWPC5SYW10
14ft: NWPC5SYW14
25ft: NWPC5SYW25
50ft: NWPC5SYW50



Green Snagless Cable

24AWG

UTP 350MHz
UL LISTED: E467035
1ft: NWPC5SGN01
2ft: NWPC5SGN02
3ft: NWPC5SGN03
5ft: NWPC5SGN05
7ft: NWPC5SGN07
10ft: NWPC5SGN10
14ft: NWPC5SGN14



Blue Snagless Cable

24AWG
UTP 350MHz
UL LISTED: E467035
1ft: NWPC5SBL01
2ft: NWPC5SBL02
3ft: NWPC5SBL03
5ft: NWPC5SBL05
7ft: NWPC5SBL07
10ft: NWPC5SBL10
14ft: NWPC5SBL14
25ft: NWPC5SBL25
50ft: NWPC5SBL50



Black Snagless Cable

24AWG
UTP 350MHz
UL LISTED: E467035
1ft: NWPC5SBK01
2ft: NWPC5SBK02
3ft: NWPC5SBK03
5ft: NWPC5SBK05
7ft: NWPC5SBK07
10ft: NWPC5SBK10
14ft: NWPC5SBK14
25ft: NWPC5SBK25
50ft: NWPC5SBK50



White Snagless Cable

24AWG

UTP 350MHz
UL LISTED: E467035
1ft: NWPC5SWH01
2ft: NWPC5SWH02
3ft: NWPC5SWH03
5ft: NWPC5SWH05
10ft: NWPC5SWH10
14ft: NWPC5SWH14



Grey Snagless Cable

24AWG
UTP 350MHz
UL LISTED: E467035
1ft: NWPC5SGR01
2ft: NWPC5SGR02
5ft: NWPC5SGR05
7ft: NWPC5SGR07
10ft: NWPC5SGR10
14ft: NWPC5SGR14
25ft: NWPC5SGR25



Red Non-Booted Cable

24AWG
UTP 350MHz
UL LISTED: E467035
3ft: NWPC5NRD03



Orange Non-Booted Cable

24AWG
UTP 350MHz
UL LISTED: E467035
7ft: NWPC5NOR07



Yellow Non-Booted Cable

24AWG
UTP 350MHz
UL LISTED: E467035
7ft: NWPC5NYW07



CAT5E PATCH CORDS

Green Non-Booted Cable

24AWG
UTP 350MHz
UL LISTED: E467035
3ft: NWPC5NGN03
5ft: NWPC5NGN05
7ft: NWPC5NGN07
10ft: NWPC5NGN10



Blue Non-Booted Cable

24AWG
UTP 350MHz
UL LISTED: E467035
5ft: NWPC5NBL05
7ft: NWPC5NBL07
10ft: NWPC5NBL10
14ft: NWPC5NBL14
25ft: NWPC5NBL25



Black Non-Booted Cable

24AWG
UTP 350MHz
UL LISTED: E467035
1ft: NWPC5NBK01
2ft: NWPC5NBK02
5ft: NWPC5NBK05
7ft: NWPC5NBK07
10ft: NWPC5NBK10
14ft: NWPC5NBK14
25ft: NWPC5NBK25
50ft: NWPC5NBK50



White Non-Booted Cable

24AWG
UTP 350MHz
UL LISTED: E467035
3ft: NWPC5NWH03



5ft: NWPC5NWH05
7ft: NWPC5NWH07
10ft: NWPC5NWH10
14ft: NWPC5NWH14
25ft: NWPC5NWH25
50ft: NWPC5NWH50

Grey Non-Booted Cable

24AWG
UTP 350MHz
UL LISTED: E467035
3ft: NWPC5NGR03
5ft: NWPC5NGR05
7ft: NWPC5NGR07
10ft: NWPC5NGR10
14ft: NWPC5NGR14
25ft: NWPC5NGR25



CAT6 PATCH CORDS

Red Snagless Cable

23AWG
UTP 550MHz
UL LISTED: E467035
1ft: NWPC6SRD01
2ft: NWPC6SRD02
3ft: NWPC6SRD03
5ft: NWPC6SRD05
7ft: NWPC6SRD07
10ft: NWPC6SRD10
14ft: NWPC6SRD14
25ft: NWPC6SRD25
50ft: NWPC6SRD50



Orange Snagless Cable

23AWG
UTP 550MHz
UL LISTED: E467035
1ft: NWPC6SOR01
2ft: NWPC6SOR02
3ft: NWPC6SOR03
5ft: NWPC6SOR05
7ft: NWPC6SOR07
10ft: NWPC6SOR10



Yellow Snagless Cable

23AWG
UTP 550MHz
UL LISTED: E467035
1ft: NWPC6SYW01
2ft: NWPC6SYW02
3ft: NWPC6SYW03
5ft: NWPC6SYW05
7ft: NWPC6SYW07
10ft: NWPC6SYW10



14ft: NWPC6SYW14
25ft: NWPC6SYW25
50ft: NWPC6SYW50

Green Snagless Cable

23AWG
UTP 550MHz
UL LISTED: E467035
1ft: NWPC6SGN01
2ft: NWPC6SGN02
3ft: NWPC6SGN03
5ft: NWPC6SGN05
7ft: NWPC6SGN07
10ft: NWPC6SGN10
14ft: NWPC6SGN14
25ft: NWPC6SGN25
50ft: NWPC6SGN50



Blue Snagless Cable

23AWG
UTP 550MHz
UL LISTED: E467035
1ft: NWPC6SBL01
2ft: NWPC6SBL02
3ft: NWPC6SBL03
5ft: NWPC6SBL05
7ft: NWPC6SBL07
10ft: NWPC6SBL10
14ft: NWPC6SBL14
25ft: NWPC6SBL25
50ft: NWPC6SBL50



Black Snagless Cable

23AWG
UTP 550MHz
UL LISTED: E467035

1ft: NWPC6SBK01
2ft: NWPC6SBK02
3ft: NWPC6SBK03
5ft: NWPC6SBK05
7ft: NWPC6SBK07
10ft: NWPC6SBK10
14ft: NWPC6SBK14
25ft: NWPC6SBK25
50ft: NWPC6SBK50



White Snagless Cable

23AWG
UTP 550MHz
UL LISTED: E467035
1ft: NWPC6SWH01
3ft: NWPC6SWH03
5ft: NWPC6SWH05
7ft: NWPC6SWH07
10ft: NWPC6SWH10
14ft: NWPC6SWH14
25ft: NWPC6SWH25
50ft: NWPC6SWH50



Grey Snagless Cable

23AWG
UTP 550MHz
UL LISTED: E467035
1ft: NWPC6SGR01
2ft: NWPC6SGR02
3ft: NWPC6SGR03
5ft: NWPC6SGR05
7ft: NWPC6SGR07
10ft: NWPC6SGR10
14ft: NWPC6SGR14
25ft: NWPC6SGR25
50ft: NWPC6SGR50



CAT6 PATCH CORDS

Red Non-Booted Cable

23AWG
 UTP 550MHz
 UL LISTED: E467035
 3ft: NWPC6NRD03
 7ft: NWPC6NRD07
 25ft: NWPC6NRD25



Orange Non-Booted Cable

23AWG
 UTP 550MHz
 UL LISTED: E467035
 25ft: NWPC6NOR25



Yellow Non-Booted Cable

23AWG
 UTP 550MHz
 UL LISTED: E467035
 1ft: NWPC6NYW01
 3ft: NWPC6NYW03
 5ft: NWPC6NYW05
 7ft: NWPC6NYW07



Green Non-Booted Cable

23AWG
 UTP 550MHz
 UL LISTED: E467035
 1ft: NWPC6NGN01
 2ft: NWPC6NGN02



3ft: NWPC6NGN03
 5ft: NWPC6NGN05
 7ft: NWPC6NGN07
 10ft: NWPC6NGN10
 14ft: NWPC6NGN14
 25ft: NWPC6NGN25
 50ft: NWPC6NGN50

Blue Non-Booted Cable

23AWG
 UTP 550MHz
 UL LISTED: E467035
 1ft: NWPC6NBL01
 2ft: NWPC6NBL02
 3ft: NWPC6NBL03
 5ft: NWPC6NBL05
 7ft: NWPC6NBL07
 10ft: NWPC6NBL10
 14ft: NWPC6NBL14
 25ft: NWPC6NBL25



Black Non-Booted Cable

23AWG
 UTP 550MHz
 UL LISTED: E467035
 1ft: NWPC6NBK01
 2ft: NWPC6NBK02
 5ft: NWPC6NBK05
 7ft: NWPC6NBK07



10ft: NWPC6NBK10
 14ft: NWPC6NBK14
 25ft: NWPC6NBK25
 50ft: NWPC6NBK50

White Non-Booted Cable

23AWG
 UTP 550MHz
 UL LISTED: E467035
 1ft: NWPC6NWH01
 3ft: NWPC6NWH03
 5ft: NWPC6NWH05
 7ft: NWPC6NWH07
 10ft: NWPC6NWH10
 14ft: NWPC6NWH14
 25ft: NWPC6NWH25
 50ft: NWPC6NWH50



Grey Non-Booted Cable

23AWG
 UTP 550MHz
 UL LISTED: E467035
 3ft: NWPC6NGR03
 5ft: NWPC6NGR05
 7ft: NWPC6NGR07
 10ft: NWPC6NGR10
 14ft: NWPC6NGR14
 25ft: NWPC6NGR25
 50ft: NWPC6NGR50



BULK CABLE



CAT5E PVC Solid Cable

1000ft
 24AWG
 UTP 350MHz
 UL LISTED: E467035
 Grey: NWCB5E-04
 White: NWCB5E-09
 Blue: NWCB5E-19
 Green: NWCB5E-20
 Other Colors: order-to-make



CAT5E Plenum CMP Cable

1000ft
 24AWG x 4P
 UTP 350MHz
 Jacket: CMP
 4 Pairs x CMP
 UL LISTED: E467035
 Blue: NWECAT5BL
 White: NWECAT5WH
 Green: NWECAT5GN
 Other Colors: order-to-make



CAT5E Shielded Cable

1000ft
 24AWG
 FTP CMR 350MHZ
 UL LISTED: E467035
 Grey: NWSCAT5GR

BULK CABLE



**CAT6
PVC Solid Cable**
 1000ft
 23AWG x 4 Unshielded Pairs
 UTP 550MHz
 CMR
 UL LISTED: E467035
 Blue: NWCB6-19
 White: NWCB6-09
 Orange: NWCB6-15
 Green: NWCB6-20
 Yellow: NWCB6-23
 Other Colors: order-to-make



**CAT 6
Plenum CMP Cable**
 1000ft
 23 AWG
 Jacket: CMP
 550 MHz
 4 Pairs x CMP
 UL LISTED: E467035
 Blue: NWPCAT6BL
 Black: NWPCAT6BK
 Green: NWEPCAT6GN
 White: NWEPCAT6WH
 Other Colors: order-to-make



Cross Wire
 1000ft
 1 Pair
 WH/BLU CROSS CONNECT
 Item Number: NWBC1X
 Other Colors: order-to-make



Cross Wire
 1000ft
 2 Pair
 WH/BLU ORG/WH X-CONNECT
 Item Number: NWBC2X
 Other Colors: order-to-make



Silver Satin Modular Cable Reel

Item ID: NWBC41	Item ID: NWBC61	Item ID: NWBC85
Pin: 4PIN	Pin: 6PIN	Pin: 8PIN
Length: 1000ft	Length: 1000ft	Length: 500ft
Item ID: NWBC45	Item ID: NWBC81	
Pin: 4PIN	Pin: 8PIN	
Length: 500ft	Length: 1000ft	

LADDER RACK

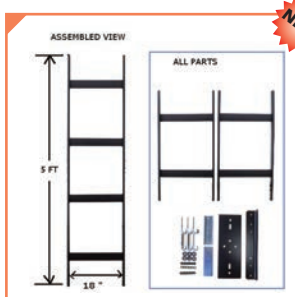

NWLR5F18K
 Ladder Rack
 With Wall Mount Kits
 5' Length, 18" Width
 Extendable to Multiply 2.5'

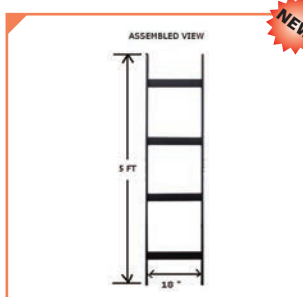

NWLR5F18
 Ladder Rack
 Without Wall Mount Kits
 5' Length, 18" Width
 Extendable to Multiply 2.5'

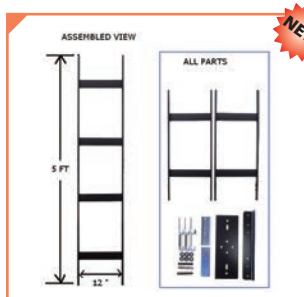

NWLR5F12K
 Ladder Rack
 With Wall Mount Kits
 5' Length, 12" Width
 Extendable to Multiply 2.5'



NWLR5F12
 Ladder Rack Only
 Without Wall Mount Kits
 5' Length, 12" Width
 Extendable to Multiply 2.5'

RACK SYSTEM



NEW

SIDE VIEW FRONT VIEW

18" 20" 12 U

NWSR12U
Swing Rack 12U



NEW

ASSEMBLED SIDE VIEW ASSEMBLED FRONT VIEW

ALL PARTS

NWSR26U
Swing Rack 26U



NEW

NWFR12U20
Fixed Rack, 12U, 19" width, 20" depth



NEW

NWRRS20
19" 2U Tray with 20" Depth



NEW

NWRRS40
Adjustable Fixed Shelf for Data Cabinets 19" x (20"-40") x 1.34"



NEW

NWRR47
Relay Rack, 47U, Black, Open Rack



NEW

NWRRS1
Relay Rack, 14" Depth Cantilever Slab



NEW

NWRRS2
Relay Rack Cantilever Slab, Double Sided



NEW

NWRRS3
Relay Rack, 15" Depth Cantilever Slab



NEW

NWCAT12
3/4 inch J Hook



NEW

NWCAT12B
3/4 inch J Hook With Bat Wing



NEW

NWCAT32B
2 inch J Hooks With Bat Wing

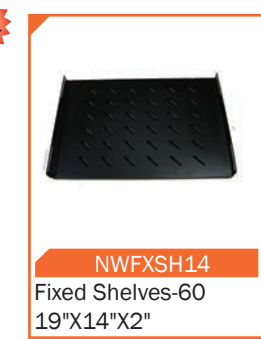

NEW

NWFXXSH14
Fixed Shelves-60 19"X14"X2"



NEW

NWFXXSH24
Fixed shelves, 19"x24.5"x2"



NEW

NWCFB60-1.2
Sliding Shelves- 60



NEW

NWNCB18U
18U Network Cabinet D24" X W24"



NEW

NWNCB1226
12U Wall Mount Cabinet W23.6" X D26"



NEW

NWNCB1826
18U Cabinet, With 26" Depth



NWNCB42
42U Network Cabinet 80"X24"X24"



NWSCB46
46U Server CAB W31.50" X D39"



NWSCB48
48U Server Cabinet W31.50 X D47.24"

NETWORK ACCESSORIES



NW-1105

110 Block, C5



NW66B

66 Block, 50 Pairs



NW66R

66 Block Rack



NWBS1P-

Bridging Switch
Available Colors:
13 14 Metal: NWBS1P-M



NWBT45-

RJ45 Boot

Available Colors:
02 04 09 13 14 19 20 22



NWCT08-

Cable Tie, 8 Inch, Available Colors:

02 09 13 14 19 20



Inline Coupler

NWIC4C-	6P4C	09 22
NWIC6C-	6P6C	09 10
NWIC8C-	8P8C	09 10



NWKJ5E-

CAT5E Keystone Jack
Available Colors:
02 04 20 22 09 13 14 15 19



NWKJ6E-

CAT6 Keystone Jack
Available Colors:

02 09 13 14 15 19 22



Modular Plug 6P4C

Stranded: NWMPST11
Solid: NWMPSL11



Modular Plug 6P6C

Stranded: NWMPST12
Solid: NWMPSL12



Modular Plug 8P8C

Stranded: NWMPST45
Solid: NWMPSL45



NWMP4CS

Modular Plug 4P4C, RJ22



CAT6 Modular Plug

Stranded: NWMPSTC6
Solid: NWMPSLC6



NWMPLS

Single Gang Caddy Fastener



NWPDTLA11

110 Style Putch Down Tool



NWWWM

7 FT Vertical Wire Management



NWCM1U

D-Ring Wire Management



NWWM1U

Closed Horizontal Wire Management, 1U



NWWM2U

Closed Horizontal Wire Management, 2U

NETWORK ACCESSORIES



NWVWM1U
Velcro 1U Wire Management

NEW



NWMH24
24 Ports Mounting Hinge



NWMH48
48 Ports Mounting Hinge



NWPP24E
Patch Panel, 24 Ports, CAT5E



NWPP48E
Patch Panel, 48 Ports, CAT5E

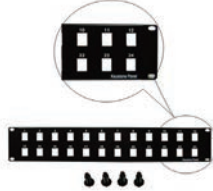

NWPPB24E
Blank Patch Panel, 24 Ports

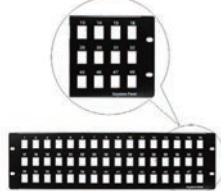

NWPPB48E
Blank Patch Panel, 48 Ports



NWPPC24
Patch Panel, 24 Ports, CAT6



NWPPC48
Patch Panel, 48 Ports, CAT6



NWVPP612
CAT6 Vertical Patch Panel, 12 Ports



NWVPP12
Vertical 12 Ports Patch Panel



NWPPDC
Dust Cover for Patch Panel

NEW



NWPPSR24
Strain Relief Bar for 24 Ports Patch Panel



NWSJ12-09
CAT6 Surface Mounting Box, Color: white

NEW



NWSJ12-09
Surface Mount Jack, RJ12, Color: White



NWSJ5-
Surface Mount Jack, RJ45, Available Color: **09 22**



NWSMB1-
CAT5 Surface Mounting Box, 1 Port, **09 22**



NWSMB2-
CAT5 Surface Mounting Box, 2 Ports, **09 22**



NWTL6P6C
Crimping Tool, 4P4C/6P6C



NWTL8P8C
Crimping Tool, 6P6C/8P8C

NETWORK ACCESSORIES



NWPDTLB

Crimpling Tool for Key Stone Jack



NWTS4C

Twist Stopper, Clear



NWTS4CL

Twist Stopper, Long k, Black



NWWP6P4CID

Wall Plate Jack 6P4C, Double, Color: Ivory.



NWWP6P4CWD

Wall Plate Jack 6P4C, Double, Color: White



NWWP1P

Wall Plate, 1 Port, Available Colors: **09 22**



NWWP2P

Wall Plate, 2 Ports, Available Colors: **09 22**



NWWP3P

Wall Plate, 3 Ports, Available Colors: **09 22**



NWWP4P

Wall Plate, 4 Ports, Available Colors: **09 22**



NWWP6P

Wall Plate, 6 Ports, Available Colors: **09 22**



NWBI-09

Blank Insert, Available Colors: **09 22**



NWUSBFM06

USB Female to Male, 6 ft



NWUSBFM14

USB Female to Male, 14 ft



NWUSBMM06

USB Male to Male, 6 ft



NWUSBMM14

USB Male to Male, 14 ft



NWUSBMM25

USB Male to Male, 25 ft



NWASM512

Screw M5X12



NWVC34

Velcro, 3/4" width, 75 feet



NWCBFAN

Fan Kit



NWCBBN

Bolts & Nuts for Cabinet, 50/PAK

FIBER OPTIC CABLE



NWFLCLCDUPMM
 Corning Fiber, LC to LC
 DUPLEX 62.5mm
 1, 2, 3, 5, 7, 10 meter(s)
 available



NWFSCSCDUPMM
 Corning Fiber, SC to SC
 DUPLEX 62.5mm
 1, 2, 3, 5, 7, 10 meter(s)
 available



NWFLCSCDUPMM
 Corning Fiber, LC to SC
 DUPLEX 62.5mm
 1, 2, 3, 5, 7, 10 meter(s)
 available



NWFLCLCOM3
 Corning Fiber, LC to LC
 DUPLEX 50 MICRO, OM3,
 10 GIG, 1, 2, 3, 5, 7, 10
 meter(s) available



NWFSCSCOM3
 Corning Fiber, SC to SC
 DUPLEX 50 MICRO, OM3,
 10 GIG, 1, 2, 3, 5, 7, 10
 meter(s) available



NWFLCSCOM3
 Corning Fiber, LC to SC
 DUPLEX 50 MICRO, OM3,
 10 GIG, 1, 2, 3, 5, 7, 10
 meter(s) available



NWFLCLCOM4
 Corning Fiber, LC to LC
 DUPLEX 50 MICRO, OM4,
 40 GIG, 1, 2, 3, 5, 7, 10
 meter(s) available



NWFSCSCOM4
 Corning Fiber, SC to SC
 DUPLEX 50 MICRO, OM4,
 40 GIG, 1, 2, 3, 5, 7, 10
 meter(s) available



NWFLCSCOM4
 Corning Fiber, LC to SC
 DUPLEX 50 MICRO, OM4,
 40 GIG, 1, 2, 3, 5, 7, 10
 meter(s) available



NWFLCLCDUPSM
 Corning Fiber, LC to LC
 DUPLEX Single Mode,
 1, 2, 3, 5, 7, 10 meter(s)
 available



NWFSCSCDUPSM
 Corning Fiber, SC to SC
 DUPLEX Single Mode,
 1, 2, 3, 5, 7, 10 meter(s)
 available



NWFLCSCDUPSM
 Corning Fiber, LC to SC
 DUPLEX Single Mode,
 1, 2, 3, 5, 7, 10 meter(s)
 available



102701-1
 Fiber Cable,
 (NTAB1829), 7 FT

AMPHENOL CABLE



180 Degree Female to Female

Available Lengths:
 10ft: NW25AMP180FF10
 25ft: NW25AMP180FF25



180 Degree Male to Female

Available Lengths:
 10ft: NW25AMP180MF10
 25ft: NW25AMP180MF25



180 Degree Male to Open

Available Lengths:
 20ft: NW25AMP180MX20
 25ft: NW25AMP180MX25
 50ft: NW25AMP180MX50
 75ft: NW25AMP180MX75



90 Degree Female to Female

Available Lengths:
 10ft: NW25AMPFF10
 15ft: NW25AMPFF15
 20ft: NW25AMPFF20
 25ft: NW25AMPFF25
 30ft: NW25AMPFF30
 40ft: NW25AMPFF40
 50ft: NW25AMPFF50



90 Degree Female to Open

Available Lengths:
 1ft: NW25AMPFX1
 25ft: NW25AMPFX25
 40ft: NW25AMPFX40
 50ft: NW25AMPFX50



90 Degree Male to Female

Available Lengths:
 5ft: NW25AMPMF5
 10ft: NW25AMPMF10
 15ft: NW25AMPMF15
 20ft: NW25AMPMF20
 25ft: NW25AMPMF25
 30ft: NW25AMPMF30
 40ft: NW25AMPMF40
 50ft: NW25AMPMF50



90 Degree Male to Male

Available Lengths:
 5ft: NW25AMPMM5
 10ft: NW25AMPMM10
 15ft: NW25AMPMM15
 20ft: NW25AMPMM20
 25ft: NW25AMPMM25
 40ft: NW25AMPMM40
 50ft: NW25AMPMM50
 100ft: NW25AMPMM100



90 Degree Male to Open

Available Lengths:
 1ft: NW25AMPMX1
 25ft: NW25AMPMX25
 50ft: NW25AMPMX50
 75ft: NW25AMPMX75
 100ft: NW25AMPMX100

COMPONENT



360301

Button Set for
SPECTRALINK i640



360302

Battery Rel. Buttons for
SPECTRALINK i640



360501-03

Housing Set for
SPECTRALINK i640



360704-02

Blank Lens for
SPECTRALINK i640



360901

LCD for
SPECTRALINK i640



361701

Air Dust Cover for
SPECTRALINK i640 / 3626
/ PTX 150



362701

Small Speaker for
SPECTRALINK i640



362702

Big Speaker for
SPECTRALINK i640



362703

Washer for MFC i640



362704

Battery contact for
SPECTRALINK or AVAYA
PTX150, i640, 3626



362705

Rubber for
SPECTRALINK i640



390102

Blank Label for
SPECTRALINK 6020



390301

Button Set for LTB 100 /
SPECTRALINK 6020



390501

Housing for LTB 100 /
SPECTRALINK 6020



390901

LCD for
SPECTRALINK 6020



391701

Air Dust Cover for
SPECTRALINK 6020



391702

Rubber Component for
Battery for
SPECTRALINK 6020



391703

Rubber Gasket for
SPECTRALINK 6020

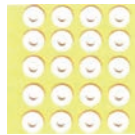

392701

Washer for MIC 6020,
Double Side Glue



392702

MIC without Rubber for
SPECTRALINK 6020

COMPONENT



NEW

392703

Ring Vibrator



410101

Green Label for Battery
Charger for PTS330 /
PTS360



411701

Battery Charger for
PTS330 / PTS360



410201

Area Code Desi & Plastic Set
for
SPECTRALINK PTB 410



410301

Button Set for
SPECTRALINK PTB 410



410501

Housing
SPECTRALINK PTB 410



410702

Blank Lens for
SPECTRALINK PTB 410



410901

LCD for
SPECTRALINK PTB 410



411702

Air Dust Cover for
SPECTRALINK PTB 410



412702

Battery for
SPECTRALINK PTB 410



420102

Blank Tag for
6140 Wireless Phone



420301

Button Set for
6140 Wireless Phone



420501

Housing for
6140 Wireless Phone



420901

LCD for
6140 Wireless Phone



421701

Air Dust Cover for
6140 / 3645

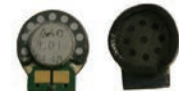

422701

Speaker for
6020/6140/3641/3645

NEW



430102

Logo Tag for
3645



430301

Dial Button for
3645



430501

Housing for
3645



430702

Faceplate for
3645

COMPONENT



430901
LCD for 3645



440102
Logo Tag for 6120



440301
Button for 6120



440501
Housing for 6120



440703
LCD Faceplate for 6120



440901
LCD for 6120



460102
Logo Tag for AVAYA3641



460301
Button for AVAYA3641



460501
Housing for AVAYA3641



460901
LCD for AVAYA3641



461701
Air Dust Cover for AVAYA3641



640301
Buttons for EnGenius



640701
LCD LENS for EnGenius, Green



640702
LCD LENS for EnGenius, Blue



702703
8440 Attery Clip Kit



470301
Dial Button for 8440



470501
Housing Set for 8440, Blue



470502
Housing Set for 8440, Black



470701
Blue Faceplate for 8440



470702
Black Faceplate for 8440

HANDSET



331401-03
Handset for **7900**



NEW
331405-03
Handset for **6900,8800,8900,9900**



NEW
331451-03
Handset With Noise Cancellation for **7900**



NEW
331455-03
Handset With Noise Cancellation for **8800,8900,9900**



NEW
331411-03
PUSH-TO-TALK for **7900**
except **7931** phone,
Charcoal

POWER SUPPLY



331101
Power Supply for **7900**
Series



NEW
331102
CISCO Power Supply



NEW
331103
CISCO LINSYS SPA Power Supply



333001
Three-Prong Power Cord



NEW
331112
OEM Power Supply W/ "L"
Plug for **8811,8841, 8851,**
8861 ,8961,9951,9971

LCD



NEW

330925
LCD for 7925G wireless



330940
LCD for 7940 / 7960



330941
LCD for 7941/ 7961/7942 / 7962



330945
Color LCD for 7945G/7965G

COMPONENT



330101
Icon label for 7900 Series



330701
Faceplate for 7940 /LCD



330702
Faceplate for 7960 LCD



330703
Faceplate for 7970/7971



330704
Faceplate for 7941 Series



330705
LCD Faceplate for 7961 Series



330706
LCD Faceplate for 7940 Series



330707
LCD Faceplate for 7960 Series



330742
Faceplate for 7942



330762
Faceplate for 7962



330765
LCD Faceplate for 7965



330720
LCD Faceplate for 7945



330775
LCD Faceplate for 7975



330781
Faceplate for 8961/9951



330782
Faceplate for 9971



330722
Faceplate for 7971 Series

COMPONENT



NEW

330300
Dial buttons for
7900 Series



NEW

330301
Feature Button for
7940/60



NEW

330302
Line Button for 7941/61



NEW

330303
Line Button(T) for
7940/60



NEW

330304
Line Button(S) for
7940/60/41/61



NEW

330305
Arrow Button for
7900 Series



NEW

330306
"?" Button for
7900 Series

REAR VIEW FRONT VIEW



NEW

330307
Display Button for
7945/7965



NEW

330325
Parts cisco-key pad for
7925G



NEW

330365
Button Set for
7945/7965



NEW

331701
Rubber Switch for
7940 / 7960



NEW

334701
Rubber Hook Switch
for 7940/60



NEW

331707
Rubber Hook Switch for
7941/ 7961



NEW

334702
New Rubber Switch for
7941/7961



NEW

334703
Wall Clip for
7910/40/45/60/65



NEW

334704
Wall Clip for 7970



NEW

334705
Rubber Feet for
7900 Series



NEW

334706
Rubber Feet for
7900 Series Stand



NEW

334709
Rubber Feet for 7905/12
Stand



NEW

334721
Circle Switch with Rubber for
7940/41/60/61/70

BACK VIEW FRONT VIEW

COMPONENT



334712
Circle Switch with Rubber for 7905/06/11/12



334715
Spring for Phone



334722
Plunger (Plastic Hook Switch) for 7940/60



332702
Plunger (Plastic Hook Switch) for 7941 / 61

FRONT VIEW



BACK VIEW

332703
Message Indicator on Top Housing 7940/60

FRONT VIEW



BACK VIEW

332704
Message Indicator on Top Housing 7941/61



332705
Message Indicator on Top Housing 7942/45/62/65



332725
Ring Vibrator for 7925



FRONT REAR

332726
Receiver for 7925



332727
Speaker for 7925



332733
Console Cable, DB9 to RJ45



330401
Stand Lock for 7910/40/60

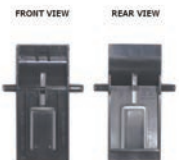

FRONT VIEW REAR VIEW

330402
Stand Lock for IP Phone 7970



330403
Stand for IP Phone 7940/41/60/61/70



330404
Stand Lock for 7905/06/11/12



330501
Top Housing 7940/60



330502
Top Housing for 7941/61



330503
Bottom Housing 7940/60



330504
Top Housing 7942/62



330505
Top Housing for 7945/65

COMPONENT



NEW

330525

Parts Housing for
7925G

NEW

330405

Generic Stand for
SPA Phone

NEW

332728

OEM Size Screws for
7925G Housing

ELECTRONIC COMPONENTS

331770	SST 28SF040A 90-4C-NH 0447388-E	331771	ESS VideoDrive ES3880FM S334 ATPBG18192
331771	ESS VideoDrive ES3880FM S334 ATPBG18192	331772	RTL8019AS 48228Q1 434F TAIWAN
331772	RTL8019AS 48228Q1 434F TAIWAN	331773	KENDIN KS8993 0431A3 GCN2828 1543002
331773	KENDIN KS8993 0431A3 GCN2828 1543002	331774	ESMT M11L16161SA- 45T KZS1AG2HH 0429
331774	ESMT M11L16161SA- 45T KZS1AG2HH 0429	331775	DELTA LANF7307 0444
331775	DELTA LANF7307 0444	331780	08-0765-07 CT0622 P31781795 M5A
331780	08-0765-07 CT0622 P31781795 M5A	331781	S29GL128M10TIR20625MFM GG
331781	S29GL128M10TIR20625MFM GG	331782	E157654FO0A F06270262
331782	E157654FO0A F06270262	331783	625 K4S561632E-UC75 SAMSUNG
331783	625 K4S561632E-UC75 SAMSUNG	331784	08-0687-01G CT0605 P31 768644 M5A
331784	08-0687-01G CT0605 P31 768644 M5A	331785	AM29LV800B-70EC
331785	AM29LV800B-70EC	331786	AD73311, 7940 PHONE
331786	AD73311, 7940 PHONE	331787	54CFC6M/LV4053A, 7940PHONE
331787	54CFC6M/LV4053A, 7940PHONE	331788	PI74FCT, 7940 PHONE
331788	PI74FCT, 7940 PHONE		
331770	SST 28SF040A 90-4C-NH 0447388-E		

BUTTON & USER GUIDE

NORTEL



101814
User Guide for
i1140



101822
User Guide Kit for
i2002

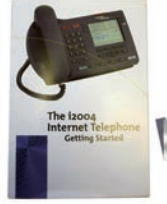

101824
User Guide Kit for
i2004



101827
User Guide for
i2007



100324
Printer Button Set for
i2004



100353
English Button for IP Phone
1200 Series



100354
Icon Button for
IP Phone 1200 Series



100345
Feature Button Set for
IP Phone 1150



100342
Function Button for
1120 / 1140 Series



100343
Function Button for
1120 / 1140 Series



101820
User Guide for
M2000 Series

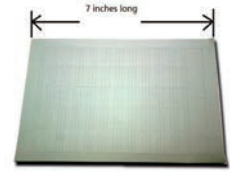

100120-1
Desi Paper for
M2000 Series



101825
User Guide for
M2250



100126
Preprint Desi Paper for
M2000



100320
Button And User Guide for
M2000 Series



100320-D
Dial Button for
M2000 Series



100322
22 BTN for M2008, M2616
Add On Moular



100325
Button And User Guide for
Console M2250



101839
User Guide for
M3902/M3903 /M3904



100139-1
Desi Area Code Retainer for
M3900

IP Phones

IP Phones

M2000 Series

M2000 Series

M3900 Series

BUTTON & USER GUIDE

M3900 Series



100330

Button for
M3900 Series



1100334

Additional Buttons for
M3905



100335

Button for
M3905



100336

Button And User Guide for
M3905

M3900 Series



100338

Expansion Module Lit Pak.
for M3900 Series



100339

Button And User Guide for
M3902 / M3903 /M3904



100340

Dial Button Set for
M3900 Series



100341

Button And User Guide for
M3901

M5000 Series

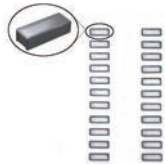

100349-22

Charcoal/Clear Button for
M3900 Add-on Module



100349

Charcoal/Clear Button for
M3900 Add-on Module



101850

User Guide for
M5000 Series

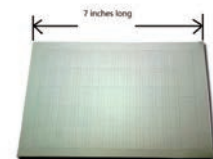

100151

Key Cap Sheet Series for
M5000 Series

T7000 Series



100350

Button And User Guide for
M5000 Series



100172-

User Guide and Desi&Plastic
for T7208 0312



100172-1

Desi paper
for T7208



100172-2

Feature List for T7208/
T7316

T7000 Series



101872-T

User Guide for
T7208

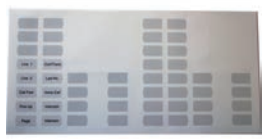

100173-1

Desi Paper for
T7316



101873-E

User Guide for
T7316E



100173-E-

User Guide And Desi &
Plastic for T7316E 0312

BUTTON & USER GUIDE

NORTEL



101874
User Guide for
T7316



101973-
User Guide And Desi &
Plastic for T7316
0312



100332
Three Icon Buttons for
T7316



100332-1
Three English Letter Buttons
for T7316



100371-
Button And User Guide for
T7100 Phone
0312



100372-
Button And User Guide for
T7208
0312



100373-
Button And User Guide for
T7316
0312



100376-
Button And User Guide for
T7316E
0312



100377
Complete Button Set
for T7208/T7316/T7316E



100378
Three LCD Function Keys for
T7310/T7310E



100379
Line Key for T Series



100170-1
Feature List Sheet for
M7000 Series



100352
Clear & Green Single Button
for M7000 Series



100370
Button And User Guide for
M7000 Series



100370-D
Dial Button for
M7000 Series



100371
Button And User Guide for
M7100 Phone



100372
Button And User Guide for
M7208



100373
Button And User Guide for
M7310



100374
Button And User Guide for
M7324



100375
Button And User Guide for
M7324

T7000 Series

T7000 Series

T7000 Series

M7000 Series

M7000 Series

BUTTON & USER GUIDE

M8000 Series



100380
Button And User Guide for
M8001/M8003



100381
Button And User Guide for
M8004



100383
Button And User Guide for
M8314



100384
Button And User Guide for
M8417

M9000 Series



100389
Button And User Guide for
M8009



100390
Button Set and User Guide
for M9316CW



100392
Button And User Guide for
M9216



100393
Button And User Guide for
M9316

M9000 Series



100394
Button And User Guide for
M9417



101893
User Guide for
M9316



101897
User Guide for M9316CW



100344
Line Key Buttons for
M2000/M5000/M7000
Series

Others



100348
48 Station Key Lamp 22
Add-on Module



100351
"MUTE" BTN,
Yellow Color



100356
Button for Wireless
7440/7449

HANDSET

M-Style



101401-
M-Style Handset
01 02 04



101404-
M-Style Amplified Handset
01 02 04



101405-
M-Style Push-To-Talk
Handset
01 02 04



101406-
M-Style Amplified Handset
W/Noise Cancellation
01 02 04

HANDSET

101412-
M-Style Handset W/Noise
Cancellation
01 02 04

101402-
T-Style Handset
03 12

101408-
T-Style Amplified Handset
03 12

101409-
T-Style Push-To-Talk Handset
03 12

101410-
T-Style Amplified Handset
W/Noise Cancellation
03 12

101414-
T-Style Handset W/Noise
Cancellation
03 12

101403-03
i1100 / 1200 Series
Handset

T-Style

IP Phones

HOUSING

100511-T
Top Housing for 1120E

100540-T
Top Housing for i1140

100524-03
Housing Set for i2004

100525-03
Housing set for i2002

100522-01
Top Housing for M2250

100533-T
Top Housing for M3903
03 12

100534-T
Top Housing for M3904
03 12

100535-T
Top Housing for M3905
03 12

IP Phones

M2000/M3900

HOUSING

M2000/M3900/M7000



100539-B-

Bottom Housing for
M3903 / 3904 / 3905

0312



100520-

Housing Set for M2008 /
M5008

010204



100526-

Housing Set for M2616 /
M5316

010204



100572-U-

Housing Horizontal Jack for
M7208

010204

M7000 Series



100572-V-

Housing Vertical Jack (Ver
3&4) for M7208

010204



100573-V-

Housing Vertical Jack (Ver
3&4) for M7310

010204



100575-L-

Lower Jack Housing Set for
M7324

010204



100575-U-

Upper Jack Housing Set for
M7324

010204

T7000 Series



100573-U-

Housing Horizontal Jack (Ver
5&6) for M7310

010204



100576-B-

Bottom Housing for T7208

0312



100576-T-

Top Housing for T7208

0312

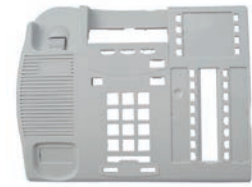

100577-T-

Top Housing for T7316

0312

T7000 Series

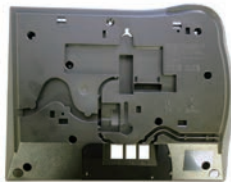

100578-B-03

Bottom Housing for
T7316/T7316E

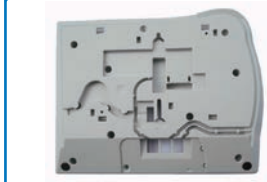

100578-B-12

Bottom Housing for
T7316E



100578-T-

Top Housing for
T7316E

0312



100593-

Housing (Top, Bottom, LCD
Case) for M9316W3

0102

Wireless



100594

Housing Kit for
Wireless7440/7449

STAND



100411-03
Stand for
i1120 /i1140



100412-03
Stand Cover for
i1120/ i1140



100422-
Stand for
i2002



100424-03
Stand for
i2004

IP Phone



100420-
Base/Stand for
M2008
01 02 04



100431-
Stand for
M3901 / M3902
03 12



100436-
Add-on Stand for
M3904
03 12



100437-
Stand Set for **M3900 Series**
EXP Module
03 12

M3900 Series



100472-
Base/Stand for
M7208
01 02 04



100473-
Base/Stand for
M7310
01 02 04



100475-
Stand for **M7324**
01 02 04



100472-T-
Base for **T7208**
03 12

M7000/T7000



100473-KIT-
Directory Tray Kits for
T7316
01 02 04



100473-T-
Base for
T7316 /T7316E
03 12



100409-
9K Base/Stand for **M2216/**
M2616/M5316
01 02 04



100438-
Wall Kit for
M3903/3904/3905/i2004
03 12

Others



100439-
Stand for **M3903 / 3904 /**
3905 /i2004 03 12

Others

POWER SUPPLY & BATTERY



101101

Power Supply For 3 x8 KSU Startalk Mini
 Input: 120V, 60Hz, 0.35A Outputs: 5VAC, 0.8A 15VAC, 0.5A NT5B0505



101103

Power Supply For ATA/STARTALK FLASH Input:120VAC, 60HZ, 24W Output:24VAC, 600mA. NT8B98AA, A0688866



101104

Power Supply For Fast Rad Input: 120VAC,60 HZ,12W; Output: 9VDC,600MA. A0678121



101106

Power Supply For SAP/CAP/KLM Input: 120 VAC, 60 Hz, 9W Output: 24VDC, 250mA. NT8B60CA



101108

Power Supply for IP Phone i2002 / i2004 Old Version Input: 120V, 60Hz, 8W Output: 16VAC, 500mA.A 0619627



101109

Power Supply for Call Pilot Input:100-220, 1.0A MAX, 50-60HZ, 20-30 VA Output:+8V---1.7A, 15W MAX. A0838158



101111

Power Supply for i2002 (New Version)/ i2004(New Version)/ i2007 / 11XX Input: 100-240V~ 0.7A,50-60HZ Output: 48V 0.52A MAX.NTYS17AAE6



101112

Power Supply for BCM50 Supply Input: 100-240V, 2A, 50/60Hz; Output:19V, 6.32A (NT9T6026)



101114

Power Supply For M3904 Accessories Input:100-120VAC 60HZ 25W Output:33VDC 500mA (A0780042 NTMN80AA)



101117

Power Supply for T7406E. Input: 100-240V; Output:9V, 0.6A NT8B45AF, N0063832



101118

AASTRA 9116 Power Supply. Input: 120V AC, 60HZ, 0.1A; Output: 9V DC, 300mA. 7ft Cable,AZAT999668



101120

Power Supply for M2000 Series. A0367335 Input: 120V, 60HZ, 25W, Output: 26.7, Max:700mA A0367335

POWER SUPPLY & BATTERY



NEW

101140

Power Board for 1140E



101150

Power Supply Centrex for M5000 (Centrex) Series, A0337977, Input: 120V, 60HZ, 16W25; Output: 16VAC, 375mA A0336163 / A0337977



101180

Power Supply for M8000 / M9000 Series Phone Input: 120V, 60Hz, 8W; Output: 16VAC 250mA A0620086



102774

Belt clip for T7406/M7410



103002

Antenna for T7406



103003

BCM Power Cord for Computer & Notebook



103074-03

Battery for T7406 /M7406 1400 mAh, 3.6 VDC A0652369



103075

Battery for T7406E



103094

Battery for Digital Mobility Wireless 7440/7449

LCD DISPLAY



NEW

100920

Nortel/ AVAYA 1120 Phone LCD



NEW

100940

Non-OEM for 1140E/1150 LCD Display

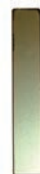

100920-V

Line Indicator, Vertical LCD for M2008



100926

LCD Display for M2616 Phone 16Pin

LCD DISPLAY

M3900 Series



100932

LCD Display for M3902 P/N: A0686380.



100932-02

Cable for LCD M3902



100933

LCD Display for M3903 P/N:A0686378



100933-03

Cable for LCD M3903

M3900 Series



100934

LCD Display for M3904



100934-04

Cable for LCD M3904

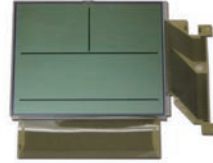

100935

LCD Display for M3905

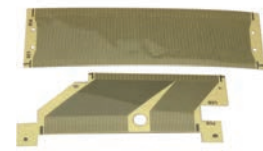

100935-05

Cable for LCD M3905

M5000/M7000



100950

LCD Display for M5316 / M5208 14Pin



100972

LCD Display for M7208/ M7100 With Bezel



100972-V

Line Indicator, Vertical LCD for M7208



100973

LCD Display With Bezel for M7310/M7324

T7000 Series



100973-V

Line Indicator, Vertical LCD for M7310



100972-T

LCD Display for T7208



100972T-V

Line Indicator, Vertical LCD for T7208



100973-E

LCD Display for T7316E

T7000 Series



100973-T

LCD Display for T7316



100973T-V

Line Indicator, Vertical LCD for T7316

LCD CASE & LENS



NEW

100721
1120E faceplate



NEW

100724
Bezel / LCD Faceplate for i2004



100740
1140E Faceplate



100228
1200 Series Area Code Retainer

IP Phone



100220
Clear Lens for M2008



100224
Clear Lens For ZK M2616



NEW

100225
M2008 Clear Lens, OEM



100226
Clear Lens for M2616

M2000 Series



100735-
Headset Plate Kit for M3905
0312



100736-
Handset Cradle Kit for M3905
0312



100730-
Logo Plate for M3900 Series
0312



100250
Clear Lens for M5312 / M5112 / M5009 / M5209

M3900 / M5000



100270
Feature List Cover for M7000 Series



100274
Clear Lens For M7208 Vertical LCD Style 3&4



100275
Clear Lens for M7208 Vertical LCD Style 5&6



100276
Clear Lens for M7310 Vertical LCD Style 3&4

M7000 Series



100277
Clear Lens for M7310 Vertical LCD Style 5&6



100772-
Lens for Norstar M7208
0203



100773-
Lens For Norstar M7310 Phone
0203



100272-
Lens for T7208
0312

T7000 Series

LCD CASE & LENS

M9000 Series



100273-

Lens for **T7316**

0312



100280

Plastic Cover for **T Series**
Tray



100670-

LCD Case for **T Series**

0312



100693-

LCD Case for **M9316CW**

0102



Others



100794

Top W/ Lens for **7440/7449**



100795

Silver Color Lens Cover
for 8.95 Digital Mobility
7440/7449



100626-

LCD Case for **M2616 /**
M2008 / M5316

010204



100726-

LCD Filler for **M2616 /**
M2008 / M5316

010204

FLEX CIRCUIT BOARD

M3900 Series

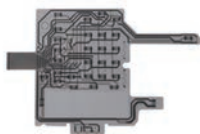

101032

M3902 Mylar



101033

Flex Circuit Board for **M3903**



101034

Flex Circuit Board for **M3904**

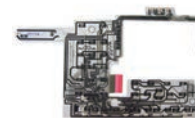

101035

Flex Circuit Board for **M3905**

M7000 Series



101072-U

Flex Circuit Board for
M7208 Upper Jack Phone
P/N: NT8B3012, NT8B3017
Style5

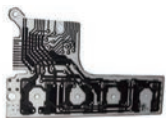

101072-V

Flex Circuit Board for
M7208, P/N:A0389033
(NT8B3007 REL-01)



101073-U

Flex Circuit Board for **M7310**
Upper Jack Phone P/N:
A0635414, (NT8B2014 /
NT8B2023)

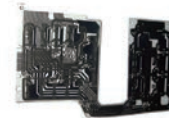

101073-V

Flex Circuit Board For
M7310 P/N:A0389032
(NT8B2007 REL-01)

T7000 Series



101072-T

Flex Circuit Board for **T7208**
P/N:A0805447

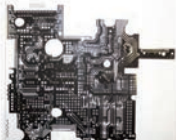

101073-T

Flex Circuit Board for **T7316**
/T7316E P/N:A0805446
(NT8B2732REL-01)

PART & COMPONENT



100214
Area Code Retainer Window & Paper for **i1140** Set



100222
Area Code Window and Paper for **i2002/i2004**



100223
i2004 Area Code Window and Paper for **i2004**



102711
i2007 Stylus, N0023003



101922-50
Rubber Dial Pad for **M2250**



100802
Hook Switch for **M2616**



100804
M2616 Message Indicator



100227
Area Code Retainer Window For **M2008/M2616**



102720
LCD Contor for **M2616**



102738-
M3900 Stand Lock **0312**



102739
Message Waiting Indicator for **M3900**



102740
Metal Clip for **M3900**



102771
Clear Plastic Cover for Waiting Message Indicator Light for **M3900**



100840
M3900 Spring



101972-U
Rubber Dial Pad for **M7208** Horizontal Jack



101972-V
Rubber Dial Pad for **M7208** Vertical Jack



101973-U
Rubber Dial Pad for **M7310** Horizontal Jack



101973-V
Rubber Dial Pad for **M7310** Vertical Jack



100807
Bezel for LCD **M7208/M7310/M7324**



100870
Hook Switch for **M7000** Vertical

IP Phone

M2000 Series

M3900 Series

M7000 Series

M7000 Series

PART & COMPONENT

M7000 Series

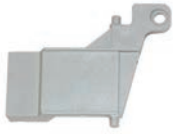

100871

Hook Switch for M7000 Upper Jack



102070

Rubber Hook Switch for M7310 Series (Vertical Jack)



102072

Triangle Key for M7000 Series



102073

Memory Line Key for M7310 Series (12BTN As One Set)

M7000 Series



102077

Hook Switch for M7310 (Horizontal Jack)



102270

Speaker for M7000 Series



102370

Washer for Speaker



102470

Mic & Mic Case for M7000 Series

M7000 Series



102470-1

Mic for M7000 Series



102570

Wall Mount Clip for M7000 Series



102573-1

LCD Function Key for M7310/M7324



102722

LCD Contor for M7310/7324

T7000 Series



102723

LCD Contor for M7208



100273-T

Tray for T7208 / T7316
0312



100382

Audio Cluster for T Series



100801

Rubber Feet for T7208/7316/7316E

T7000 Series



100876

T Series Plastic Hook Switch



100881

Screw Kits For T Series
Phone 1 CHAR 1 WHITE



100882

Screw Kits For T Series
Phone, Platinum



102724

LCD Contor for T7208

PART & COMPONENT



102725
LCD Connector for
T7316



100805
Rubber Feet
01 02 04



100806-
Swivel for LCD Case M2616
/M5316/M2008



100810
Rubber Dowel Feet

Others



100839
Hook Switch for M3900 & T
Series



102001
RLS Line Key for M2000/
M5000/M7000



102078
Micro Hook Switch for
3900/ T Series



102701
Fiber Spool Plastic Part

Others



102702
Bracket 4", 0*16, Zero Line,
16 Station



102703
Bracket 8", 12*0, 12 Line,
Zero Station



102704
Bracket 12", 0*32, Zero
Line, 32 Station



102709
Screw for 9K Phone

Others



Cable Trough Insert



LCD Contor for
M5000 Series



Speaker for 7440/7449



Receiver for 7440/7449

Others



102895
Round Clip of Battery
Cover for Mobility Housing
Wireless 7440/7449



102894
Battery Cover with Round
Holder for Mobility Housing
Wireless 7440/7449

ELECTRONIC COMPONENTS

101701 24C64W6	1017189 LVTH125	101740 QMV362AH5
101702 25C021	101719 EPF6636AQC1603	101741 QMV365BT5
101703 53C770	1017190 M37602MA-050FP	101742 QMV432BT5
101705 71F7011	1017191 M37602MA-051FP	101743 QMV453AT5
101706 74LVT125D	1017192 M37602MA-052FP	101744 QMV473BT5
101708 AD7248AAP	1017193 S1D15200F10C1	101745 QMV554GT5
101709 ADSP2181KS-133	1017194 S1D15600B00A1	101746 QMV608AH5
101710 C46CM1	1017195 S1D16702F00A1	101747 QMV635AT5
1017100 ICL7660 CBA	1017196 SED1560B0A	101748 QMV636BT5
1017106 QMV554FT5	1017197 SED1672FOA	101749 QMV647AH5
1017107 QMV473CT5	1017198 MTE53N50E	101750 QMV647AH6
1017108 SI3019-KT	1017199 SI3019-FT	101751 QMV663BT5
101711 CS61574-IL1	101720 EPM7064LC44-7	101752 QMV734AH5
1017110 AM29LV002BT-90EF	1017200 SI3050-FT	101753 QMV755AT5
1017117 Q863C	1017201 N87C51FA1	101754 QMV818P5
101712 CS61575-IL1	1017202 XPC855TZP80D4, CALL PILOTS	101755 QMV863DT5
1017124 QMV233AQ1	1017203 MC33262P	101756 QMV863BT5
1017128 QMV473AT5	1017204 TEA1095ST, M5316	101757 QMV863CT5
101713 CY7C1399-12VC	1017205 TEA1095ST	101758 QMV900AH5
101714 DS3680	1017206 M37602MA-050FP, M3904	101759 QMV902BH5
1017145 M50747-C51FP	1017207 M37620EAFP, M3904	101760 QMV964AT5
1017146 S06A, CALLPILOT	1017208 LMC76, M3903/04	101761 QTK263
1017147 E28F016S5 85 5V	1017209 LMC66, M3902	101762 SCC88692CIA44
1017148 Capacitor For 616 /824	101721 H7660	101763 SED1672F
1017149 1U CLLR ID CRDNT7B75	1017210 ATMEL440/25256W, M3904	101764 SI3015KS / SI3015-KS
101715 DS8923AN	1017211 ATMEL440/25256AW, M3904	101765 SN7469N
1017150 1D CLLR ID CRD NT7B75	1017212 74LVT125D, M3902/03	101766 SN75182N
1017151 Y15 CLLR ID CRD NT7B75	101722 H7660CBA	101769 A0744516 CHIP FOR NT8D02
101717 EPC1441PC8	101723 HC9P550B-6	101771 MC34129D
1017170 1172	101724 HCT374A	101772 SI3021KS
1017171 34119	101725 L3845	101773 M38867E8AHP, EMPTY IC
1017172 74LVC374AD	101726 L3845B1	101774 M37510M6-064F
1017174 95010W6	101727 LM7805CT	101779 NTDK20GA
1017175 9510N0	101728 LM7812CT	101780 NTAK20BD
1017176 95080W6	101729 LXT304APE	101781 NTBK51BA
1017177 95256W6	101730 Electronic Component, NT465AA, For NORSTAR Phone.	101783 QMV416AT5
1017178 AM29LV002BT-90EI	101731 Electronic Component, NT5L32, For NT8D09 Line Card.	101784 QMV354AT5
1017179 L04B	101732 Electronic Component, NT5L56, For NT8D09 Line Card	101785 PSB2163TV3
101718 EPF10K30ATC144-3	101733 Q863D/QMV1010	101786 N80C51BH, INTEL, A0349719
1017180 LC157A	101734 QMV1010-1AF5 /Q863D	101787 HCT245
1017181 LV02A	101735 QMV123BP5	101788 CAPACITOR
1017182 LV244A	101736 QMV190BT5	101790 NTAH28AG
1017183 LVC00A	101737 QMV221CP5	101791 BH-10
1017184 LVC125A	101738 QMV234AT5	101793 S2D
1017185 LVC138A	101739 QMV262AT5	101794 M37450M8-194FP
1017186 LVC374A		101795 M38002M4467FP
1017187 LVC377		
1017188 LVT125		

DESI PAPER & PLASTIC OVERLAY



110101
Merlin BIS10 Desi Paper



110101-1
Merlin BIS10-HFAI Desi Paper



110105
Merlin 5 Button Desi Paper



110122
Merlin 22B (7314) Desi Paper



110122-D
Merlin 22D (7315) Desi Paper



110111
Merlin 10/10B (7303&7403) Desi Paper



110201
Merlin BIS10-HFAI Plastic Overlay



110205
Merlin 5 BTN Desi Silver Plastic W/Glue



110211
Merlin 10/10B Silver Plastic (7303&7403)



110222
Merlin 22B (7314) Plastic Overlay



110222-D
Merlin 22D (7315) Plastic Overlay



110106
MLS6 Desi Paper



110112
MLS12 Desi Paper



110118
MLS18 Desi Paper



110139
Desi Paper for MLS 34D



110206
MLS6 Plastic Overlay



110212
MLS12 Plastic Overlay



110218
MLS18 Plastic Overlay



110110
MLX10 Desi Paper



110116
Desi Paper for MLX16DP / MLX28D

Merlin

Merlin

MLS

MLS

MLX Legend

DESI PAPER & PLASTIC OVERLAY

Euro



110210

MLX10 / Lucent 8410
Plastic Overlay



110216

Desi Plastic Overlay for
MLX16DP/28D



110118-D

Euro Button 18D Desi Paper



110118-E

Euro Button 18 Desi Paper

Euro

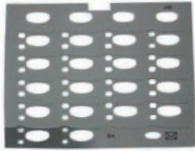

110128

New Euro 18D Desi Paper

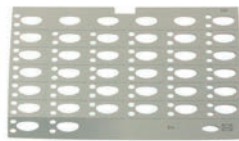

110135

Desi Paper for
New Euro 34D

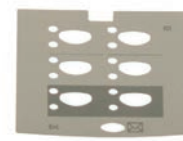

110136

Desi Paper for
New Euro 6

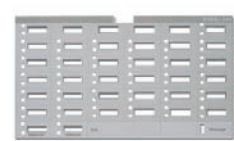

110140

Old Euro 34D Desi Paper

Euro



110160

Euro Button 6 Desi Paper



110218-D

Euro Button 18D Plastic
Overlay



110218-E

Euro Button 18 Plastic
Overlay



110228-D

New Euro 18D Plastic
Overlay

Euro



110235

New Euro 34D Plastic
Overlay

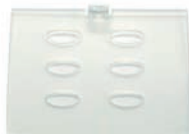

110236

New Euro 6 Plastic Overlay



110240

Old Euro 34D Plastic Overlay



110260

Euro Button 6 Plastic Overlay

Spirit



110123

Spirit 6 Desi Paper



110124

Spirit 24 Desi Paper



110223

Spirit 6 Plastic Overlay



110224

Spirit 24 Plastic Overlay

DESI PAPER & PLASTIC OVERLAY



110137
Desi Paper
MAGIX 4406D



110138
Desi Plastic for
MAGIX 4412D/4424D



110237
Plastic Overlay for
MAGIX 4406D



110238
Plastic Overlay for
MAGIX 4412D/ 4424D

Magix 4400



110164
6424 Desi Paper



110166
6416 Desi Paper



110168
6408 Desi Paper

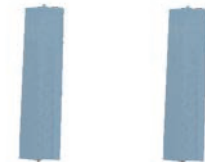

110264
6424 Plastic Overlay

Definity 6400



110266
6416 Plastic Overlay



110268
6408 Plastic Overlay



110180
Desi Paper for
CallMaster 4



110181
Desi Paper
AT&T CallMaster 2&3

CallMaster

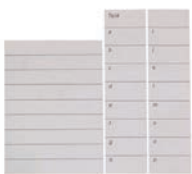

110185
Desi Paper for
CallMaster V

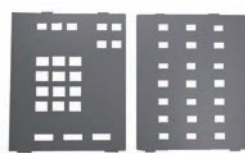

110280
Plastic Overlay for
CallMaster 4



110281
Plastic Overlay for
AT&T CallMaster 2&3



110285
Plastic Overlay for
CallMaster V

CallMaster



110184
Lucent 8410 Desi Paper



1101146
Desi Paper for
1416



1101148
Desi paper for
1408



1102146
Plastic Overlay for
1416

Definity 8400/IP Phones



DESI PAPER & PLASTIC OVERLAY

IP Phones



1102148
Plastic Overlay for 1408

DIRECTORY TRAY & USER GUIDE



110401-
MLX/Partner Directory Tray
0209



110402-
6400 Series Directory Tray
0509



111802
MLX/Merlin Legend User Guide



111822
MLX 10 Lit Pack



111833
MLX 20 Lit Pack



111803
6400 Series User Guide



111801
Partner/MLS User Guide



111811
EURO 18 Lit Pack



111812
Euro 18D Lit Pack

LCD & CASE

Definity 8400/6400



110284
LCD Plate for 8410D



110286
Clear Lens for 6400 Series LCD Case
0509



110601-
LCD Case for 6400 Series
0209



110618-
LCD Case for Euro 18D LCD Ver1 New Style
0209

Euro



110728
Lens for New Euro 18D



110619-
LCD Housing for Euro 18D Ver1 Old Style
0209



110628
LCD Housing for New EURO 18D
0209



110718
Blank Lens for Euro 18D

LCD & CASE



110903
LCD for Old Euro 18D/34D
Old/New Version



1107132
Display Lens Cover for
9630/30G/40/40G



1106122
Display Lens Kit for
9630/30G/40/40G



1106132
Complete LCD Case for
9650/9650G

9600 Series



1107123
LCD Case Cover for
9650/9650C



110961
9621 LCD V01A

NEW



110963
9641 LCD V01A

NEW



1106120
LCD case for
9620C/9620L

NEW

9600 Series



1107109
Clear LCD Lens for
9508/9608

NEW



110905
LCD for
AVAYA 9508/9608

NEW



110911
LCD for
NON-OEM AVA 9611G

NEW



110921
2410 LCD Ver1(+)
2410D01A
COMCODE:700306483

4600 Series



110922
2410 LCD (OEM), Ver 2(T)
COMCODE: 700381999



110724
2420 Faceplate



110721
2410/5410 Faceplate
Ver 1(+)
COMCODE: 700306483



110722
Faceplate for 2410 / 5410
COMCODE: 700381999



110739
4610 LCD Faceplate VER
1(+),
COMCODE: 700274673



110746
Faceplate for
4620/4621



110742
Faceplate VER 2(T) 4610
LCD

STAND

6400/Euro



110412-05

Stand for
6200 Series



110403-

Stand for
6408/6408D
05 09



110404-

Stand for
6416D+/6424D+
05 09



110406-05

Stand for
6416D+M/6424D+M

Merlin



110405-

Stand for Euro & New Euro
18 / 18D
02 04 09



110415-

Stand for
Old Euro 6
02 09



110407-

Stand for
Merlin 5 / 10 Button



110411-02

Stand for
Merlin 22 Button

MLS/MLX

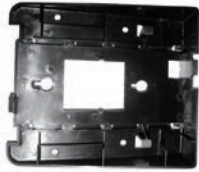

110408-

Stand for
MLS 6/12
02 09



110409-

MLX 5 / 10 / 10D / 10DP
Stand New Style Three Clips
02 09



110414-

Stand for
8410D, New Style
02 09

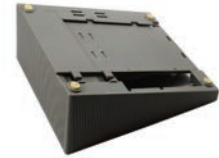

110410-

MLX10D/10DP New Version
Stand 8400 Sereis Old Style
02 09

Others



110442-

MAJIX Stand 4412/4424
02 09



110446-02

4620 / 5620 Stand



110447-02

4621 Stand



110421

2410 / 4610 / 5410 Wedge
Stand Ver1(+) Works on
"+ "Bottom Housing

Others



110422

2410 / 4610 / 5410 Wedge
Stand Ver2(T) Works on "T"
Bottom Housing



110423-

2410 / 4610 / 5410 / 5610
UNIV Stand
02 04



110424-02

2420 Stand, Black



1104122

9630/30G/40/40G/50/
50C Stand

HOUSING



110510
New Version Lucent
MLX10D/DP/8510T Top
Housing



110511-
New Style MLX10 Housing
Set
0209



110512-
New Style MLX10D Housing
Set
0209



110513-
New Style MLX10DP Housing
Set
0209



110510-B-02
Bottom Housing,
New ver for MLX10DP



110516-
Old Style MLX10D Housing
Set
0209



110518-B-
Euro 18/18D (V1&V2)
Bottom Housing
0209



110518-T-02
Top Housing for
Old Euro 18



110518D-T-
Top Housing for
Old Euro 18D
0209



110519-
Old Euro 6
Housing Set
0209



110529-02
Top, Bottom Housing for
Housing for New Euro 6



110520-
Housing Set for Old Euro
34D
0209



110528-T-
Top Housing for New Euro
18D
0209



110521
2410 Top & Bottom Housing,
Ver 1(+)



110522
2410 Top & Bottom Housing,
Ver 2(T)



110524-T
2420
Top Housing

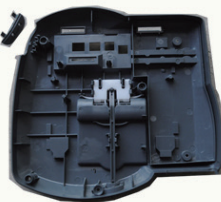

110524-B-
2420 Bottom With Puller
0209



110531-
Spirit 6 Housing Set
0209



110532-
Spirit 24 Housing Set (Top,
Bottom)
0209



110539
4610 Housing Set With Light
Pipe, Ver 1(+)

MLX Legend

MLX Legend

Euro

Definity 2400

Spirit

HOUSING

Definity 4600



110538

4620 IP Top Housing,
Purple Grey



110540-T

4620SW IP Top Housing



110538-BH

4620 Bottom Housing, H.
Jack, Purple Grey



110538-BV

4620 Bottom Housing, V.
Jack, Purple Grey

Definity 4600



110541-T

4621 Top Housing,
Purple Grey



110541-B

4621 Bottom Housing



110542

4610 Housig Ver 2(T)
COMCODE: 700381957



110544-T-02

Top Housing for
MAJIX 4406D

Magix/MLS



110545-

Housing Set for
MAJIX 4412D 0209



110550

MLS 6 Housing Set



110551-T-02

MLS 12 Housing Top



110552-

MLS 12D Housing Set
0209

MLS/6400



110553-

MLS 18D Housing Set
0209



110560-

6402 Housing Set
0509



110563-

6402D Housing Set
0509



110564-

Housing for 6408D
0509

6400 Series



110565-

6408 Housing Set
0509



110566-

Housing Set for 6416D+
0509



110567-

Housing Set for 6424D+
0509



110568-

6416D+M Housing Set
0509

HOUSING



110569-
6424D+M Housing Set
05 09



110572-T-05
Global 6408D+
Top Housing



110570-05
CallMaster V
Housing Set



110530-
Lucent CallMaster 4 Top
Housing 02 09



110571-
XM 24 Housing Set
05 09



110584-T-
8410D New Style Top
Housing
02 09



110584-B-
8410D New Style
Bottom Housing
02 09



110589-T-
8410D Old Style Top
Housing
02 09



110589-B-
8410D Old Style Bottom
Housing
02 09



1105108-B
Bottom Housing for 9508



1105108-T
Top Housing for
9508



1105109-B
Bottom Housing for
9608



1105109-T
Top Housing for 9608



1105100-T
Top Housing for 9611G



1105100-B
Bottom Housing for 9611G



1105112-C
9610 Faceplate

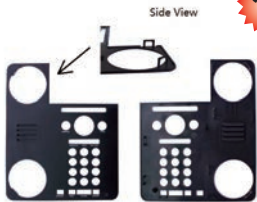

1105120-CL
9620 Top Cover, Grey, SQ
clip

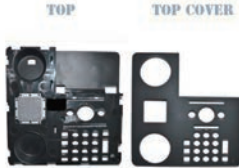

1105122-T
9630/30G/40/40G
Top w/C



1105122-B
Bottom Housing for
9630/40/50/50C



1105122-C
Top Faceplate Cover for
9630/30G/40/40G

CallMaster

Definity 8400

9500 Series

9600 Series

9600 Series

HOUSING

9600 Series

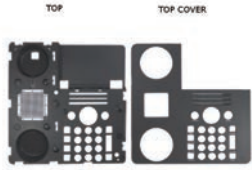

1105132-T

9650/50G
Top Housing w/C



1105132-B

Bottom Housing for
9650/50G



1105132-C

Top Housing Faceplate
Cover for 9650/50G



1105124-B

Bottom Housing for
9630G/9640G

AVAYA

HANDSET

G/R/K-Style



111403-

AT&T G-Style Handset

01 02



111404-

AT&T R-Style Handset

02 09



111420-02

R-Style Amplified

NEW



111402-

AT&T K-Style Handset

02 09 10

K-Style



111405-

K-Style Carbon Handset

02 09



111407-

K-Style Amplified Handset

02 09



111408-

K-Style Push-To-Talk Handset

02 09



111410-

K-Style Amplified Handset

W/Noise Cancellation 02 09

Euro-Style



111411-09

K-Style Push-To-Talk Handset
W/Noise Cancellation, White



111452-02

AT&T K-Style Noise
Cancellation Handset, Black

NEW



111401-

AT&T Euro-Style Handset

05 09



111418-

Euro-Style Handset W/Noise
Cancellation 02 09

Euro-Style



111412-

Euro-Style Amplified
Handset

02 05 09



111414-

Euro-Style Push-To-Talk
Handset

02 05 09



111415-

Euro-Style Amplified Handset
W/Noise Cancellation

02 09



111416-

Euro-Style Push-To-
Talk Handset W/Noise
Cancellation

HANDSET



111406-
New Euro Handset

02 09 24



111421-
New EURO 4600 Series
AMP H/S

02 24



111422-02
New EURO,
Push-To-Talk Handset



111422-24
Push-To-Talk Handset
IP 4600 Series



111429-02
Push-To-Talk for 9500/
IP1400/1600 Series, Black



111429-03
Push-To-Talk for
IP9600 Series, Charcoal



111439-02
Amplified for 9500/
IP1400/1600 Series, Black



111439-03
Amplified for
IP 9600 Series, Charcoal



111419-
IP 9600 Handset

02 03

Euro/IP 4600

IP Phone/9600

9600 Series

POWER SUPPLY



111101
Power Supply for AT&T
KS-22911 L1. 7405,
SPK201/202, Input: 120V,
60Hz, 24W
Output:48VDC/200mA



111102
Power Supply for #
1151B18434/8411/
6416 Call Master
Input: 120V, 60Hz, 500mA
Output: 48V, 420mA



111103
Phone Power for
IP PS400
Input:100-240V,50/60Hz
1.2A MAX
Output:DC 24V 1.875A



111104
OCTEL/LUCENT
Power Supply
P/N: 023 -0143 -001
Input: 60Hz, 0.45A
Output: 26V,1.54A.



111105
Power Supply for Magix
Input: 120V, 60Hz, 190mA
Output:48VDC/250mA



111110
SPPOE-1A, 1 Port POE
Injector for 9608, 9611G,
9621G/, 9641G



111111
Power Supply for 1600
Series



111112
COMPATIBLE 1151D1
Power Supply

NEW

POWER SUPPLY



NEW

111113

Power Supply for IP PS500,
AVAYA P/N: 700357387



NWPC206

Two-Prong Power Cord, 6ft



NWPC306

Three-Prong Power Cord, 6ft

FLEX CIRCUIT BOARD/MYLAR

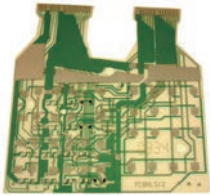

111006

Flex Circuit Board for **MLS6**

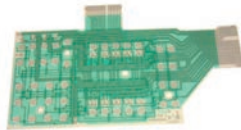

111010

Flex Circuit Board for **MLX10**



111012

Flex Circuit Board for **MLS12**

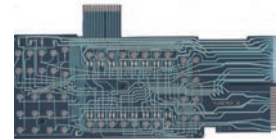

111016

Flex Circuit Board for **MLX16**



111018

Flex Circuit Board for **MLS 18**

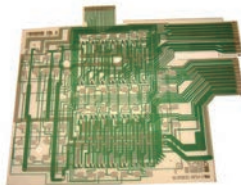

111020

Flex Circuit Board for **MLX20**

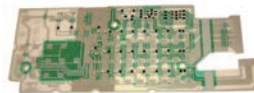

111024

Flex Circuit Board for **Spirit 24**

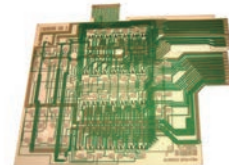

111028

Flex Circuit Board for **MLX28**

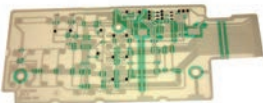

111066

Flex Circuit Board for **Spirit 6**

BUTTON/CAP



110304-18

Partner **MLS 18** Button Set, Line Button, Feature Button, Dial Button



110304-34

Partner **MLS 34** Button Set, Line Button, Feature Button, Dial Button



110304-6

Partner **MLS 6** Button Set, Line Button, Feature Button, Dial Button



110305

Partner **MLS** Feature Button



110306

Partner **MLS** Dial Button



110312-

Line Key for **MLS 34** 0209



110304-

Partner **MLS** Line Key 0209



110307-

Legend / MLX Line Key Button 0204

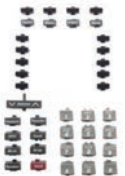

110350

MLX 10 Button Set, Line Button, Feature Button, Dial Button



110351

MLX10 New Version Button Set, Line Key Btn 14 Blank, Feature Btn, Dial Btn



110307-16

MLX 16 Button Set, Line Button, Feature Button, Dial Button



110307-20

MLX 20 Button Set, Line Button, Feature Button, Dial Button



110307-28

MLX 28 Button Set, Line Button, Feature Button, Dial Button



110308

Legend/MLX Feature Button



110309

Legend/MLX Dial Button



110312

Dial Button Set for **Callmaster**

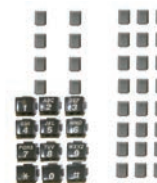

110313-1

Complete Button Set for **Callmaster I**



110313-2

Complete Button Set for **Callmaster II**

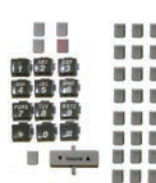

110323

Complete Button Set for **Callmaster III**



110343

Complete Button Set for **302 Console**

MLS

MLX

MLX

Callmaster

CallMaster

BUTTON & CAP

CallMaster

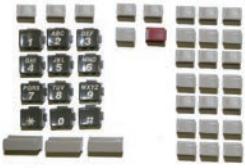

110354

Complete Button Set for Callmaster 4



110314

Button Cap for Callmaster III



110314-01

Volume Control Key for Callmaster III



110314-02

HOLD Red Button for Callmaster III

2400/5400



110311

AT&T Release, Start, Cancel Button for 327410C, 302C Console, Definity G3



110317

302C Membrane, 6-key



110318

302C Membrane, 3-key



110319

26B1, DXS CONSOLE BTN, 100+20 PC



Euro



110321

2410 / 5410 Button Set, Ver 1(+), Comcode:700306483



110322

2410 / 5410 Button Set, Ver 2(T), COMCODE:700381999



110326

Button Set for 2420 D01A new or D01B



110328

Complete Button Set for New Euro 18D

Euro

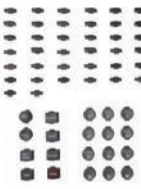

110333

Button Set for Euro 34D

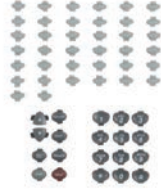

110334

Complete Button Set for New Euro 34



110335

Complete Button Set for New Euro 6D



110336

Complete Button Set for Euro 6D



Euro



110301

Partner Euro Line Key Button Color: Grey



110338

Euro 18 Button Set, Line Button, Feature Button, Dial Button



110302

Partner Euro Feature Button



110303

Partner Euro Dial Button

BUTTON/CAP



110339
Button Set for **4610 Ver 1(+)**
COMCODE:700274673



110342
Button Set for
4610 Version 2(T)
COMCODE:700381957



110348
Button Set for
4620 D01A new / 01B 4622 / 4625



110364-08
Complete Button Set for
6408D



110364-16
Complete Button Set for
6416D



110364-24
Complete Button Set for
6424D



110364-D
Dial Button for
6400 Series



110364-F6
Feature Button for
6400 Series



110364-F8
Function Button for
6400 Series



110364-L16
16 Line Keys for
6416



110364-L24
24 Line Keys for
6424



110364-L8
8 Line Keys for
6408



110365
Icon Feature Button for
6400
COMCODE: 848056362



110366
Button Kits W/O Line Key for
6400



110381
AUTO Button for
AT&T **8110**



110382
AUTO Button w/o PRINT for
8110

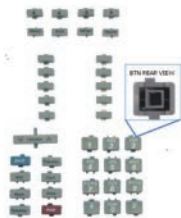

110384
Old Style Button for
8410

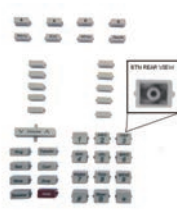

110385
New Style Button for
8410



110386
New Style Button for
8434



110387
Old Style Button for
8434

Definity 6400

Definity 6400

Definity 6400

8100 Series

Definity 8400

BUTTON/CAP

9500/9600



NEW

1103108
Button set for
Non-OEM AVAYA **9508/9608**



NEW

1103100
Button set for
Non-OEM AVAYA **9611G**



NEW

1103120
Button Set for
9620C/9620L



NEW

1103122
Button Set V1 for
9630G/40/40G

1400/9600



NEW

1103123
Button Set for
9630



NEW

1103124
4 Line Buttons for
LCD Display



NEW

1103132
Button Set for
9650/9650C



NEW

1103146
Partial Button Set for
1416/1614

1400/1600



NEW

1103148
Partial Button Set for
1408/1608



NEW

1103165
Dial Button Set for
1400/1600 Series



NEW

1103166
Navigation Button for
1400/1600 Series



NEW

1103167
Display Button for
1400/1600 Series

1400/1600



NEW

1103168
8-Line Button for
1408/1608



NEW

1103169
16-Line Button for
1416/1616

COMPONENTS



111603-
Name Tag for **6400 Series**
0509



111604
Name Tag for
4600 Series



111605
Name Tag for
2400 Series



111610-02
Name Tag for
8400

COMPONENTS

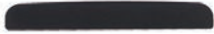

111611-0209
Name Tag for 4400 Series



112401-02
Wall Clip for Lucent MLX10D /DP /8510T

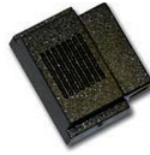

112402-02
Wall Clip for Old Euro 18/18D



112403-02
Wall Clip for New Euro 18D



112404-04
Plunger for New Euro Partner



112405
MLX Area Code Retainer Plastic And Paper



112406
Wall Mount Clip for 2420 /4621



112407
Wall Mount Clip for 4620 / 5620



112408
Hook Switch for 4620/4621



112409
Hook Switch for 2420



112410
Hook Switch for 2410, D01A Version



112411
Hook Switch for 4610, D01B Version



112412
Hook Switch for 2410, D01B Version



112710
616 Jack W/CONNE for 4610/2410 V1



112711
616 Jack W/CONNE for 4610/2410 V2



112724
Red Len for 2420/5420/4600



601702
H Series Quick Discont Extension Cord, Works on M10, M12 Modular and CALLMASTER V



111602
Blue Tip Key Kit 7 inch LC8C19Key

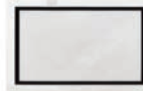

112761
Black Frame with Glue for 9621D01A

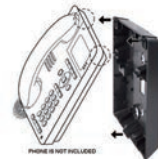

1104109
Wall Mount for 9504/9508 / 9608/9611/9620

RUBBER FEET



110801

Rubber Feet for
6400 Series



110802

Rubber Feet for
Euro



110803

Rubber Feet for
Partner MLS



110804

Rubber Feet for MLX/
Legend/ 8400 Series

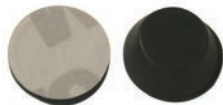

110805

Rubber Feet for
Merlin



110806

Rubber Feet for
2410 / 4610



110823

Rubber Feet for
2410 / 4610 Stand

CALLMASTER KIT



111201-

Cradle Stand for
AT&T CallMaster 1/2/3/4
0209



111202-02

Screw for Cradle Stand for
CallMaster 1/2/3/4



111203-

Callmaster Kits Including
Carbon Handset, Cradle
Stand, Screw, Two Prong
Adapter, Cord, User Guide



111204

Two Prong Plug for
Callmaster Kits Set



111206-01

Two Prong Plug, Round
Tip, OEM Adapter, Copper ,
CALLMASTER

ELECTRONIC COMPONENTS

111701 LE58QL02JC For ACS Control Unit
111702 T7513B
111704 502MU
1117100 6CAEHOK/LMV324I
1117101 L4978D/992RJV6
1117102 PE-67540NL
1117103 0637 SLVU2.8-8
1117104 AHC74/BEO4902
1117105 AHC374/AX43902
1117106 T 8950MC
1117107 DBS104G
1117108 121-5 /AB /T424
1117109 ATMEL 420 /25160AN
1117110 E6V1U1
1117111 M30620FCAFP
1117112 L T 8950MC /O610P
1117113 HDBS104G
1117114 121-5 /AG /T612
1117115 ATMEL 602 /25160AN
1117116 M30620FCFP
1117117 ATMEL522/25020AN
1117118 DF02S
1117119 SLVU2.8-4
111712 4OYLJ0002UKBA
1117120 H2019NL(PULSE)
111713 AM79ETRJC
111714 AM79ETR2JC
111715 AM79Q02JC
111716 E6V1U1
111717 93C46 6
111718 SWITCH FOR 46XX
111720T7950 MC2-LUCENT
111720-2 T7950 MC2-AGERE

111721 PS4602
111722 407590991
111723 MC68HC05C8A
111724 3403
111725 327HY
111729 LE79ETR2JC
111730 T7950MC2
111731 T7950MC1
111732 PEB2025NV1.5
111733 E6V1U1
111734 MC68NC705C8ACP
111781 LE58QL021BVC
111782 AM79ETRJC QUALITY
111784 BCM1101COKPB/CT0523P30
111785 K4S281632F-UC75
111786 LM2575HVS-3.3P+
111787 42571
111788 LMV358M
111789 LVC374A/AR753/UPG519C
111790 LVC74A/AR286
111791 0522/28F640J3
111792 CCAL4871
111793 H13A/428BE
111794 H2019AL
111795 DF01S
111796 E6V1U1
111797 BCM1101COKPBG/RT0650P30
111798 0642/48LC8M16A2-75G
111799 JS28F640/J3D75/5635B160

DESI PAPER



120101

EDE 30-1&2 Desi Paper



120102

ETE 16-2 Desi Paper Series II / Dterm II



120103

ETE 16D-2 Desi Paper Series II / Dterm II



120104

ETE 6-2 Desi Paper Series II / Dterm II



120105

ETE 6D-2 Desi Paper Series II / Dterm



120106-

ETW / ETJ-16DC Desi Paper, Series III / Dterm III

0209



120107-

ETW-8 Desi Paper Series III / Dterm III

0209



120108-

ETJ-8 Desi Paper Series III / Dterm III

0209



120109-

ETW / ETJ-16DD Desi Paper Series III / Dterm III

0209



120110

ETT 16-1 Desi Paper Series I / Dterm I



120112

Area Code Retainer Paper



120113-

DTP-8D-2 Paper Series E / Dterm E

0220



120114-

DTP-16D-2 Paper Series E / Dterm E

0220



120115-

Whole Sheet Desi Paper for Series E/DTP-8D-2

0220



120116-

Whole Sheet Desi Paper for Series E, DTP-16D-2

0220



120117

SN 716 Desi Paper

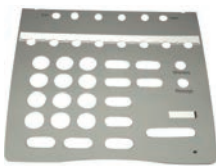

120118

Desi Paper for Series i DTH/ ITH/ DTR/ ITR 8-Button Display Phone, Silver Color

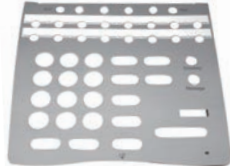

120119

Desi Paper For Series i DTH/ ITH/ DTR/ ITR 16-Button Display Phone, Silver Color



120120

Desi Paper For Series i DTH/ ITH/ DTR/ ITR 32-Button Display Phone, Silver Color



120121

Whole Sheet Desi Paper For DTH/ITH/DTR/ITR 16-Button Display Phone, Silver Color

DESI PAPER



NEW

120122

Whole Sheet Desi Paper for DTH/ITH/DTR/ITR 32-Button Display Phone, Silver Color



NEW

120124-

Whole Sheet Desi Paper for Series E 8 /DTU/DTP-8-1

02 20



NEW

120125-

Whole Sheet Desi Paper for Series E DTP/DTU 32

02 20

PLASTIC OVERLAY



120201

EDE-30-1&2 Desi Strip Clear Color



120202

ETE-16-2 Desi Strip Series II / Dterm II Clear Color



120203

ETE-16D-2 Series II / Dterm II Two Desi Strips



120204

ETE-6-2 Desi Strip Series II / Dterm II Clear Color



120205

ETE-6D Desi Strip And Window Series II / Dterm II



120206-

ETJ-16DC-2 / ETW-16DC-2 Display Cover Series III / Dterm III

03 09



120207

ETW-8-1, Clear Desi Window, Series III / Dterm III



120208

ETJ-8-1, Clear Desi Window, Series III / Dterm III



120209-

ETJ-16DD-1 / ETW-24DC-2, Display Cover, Series III / Dterm III

03 09



120210

ETT-16 Display Cover Series I / Dterm I



120211

Series III Pro Phone Light Cover



120212

Area Code Retainer Window Cover



120213

DTP-8D-2 Plastic Cover Series E / Dterm E



120214

DTP-16D-2 Plastic Cover Series E / Dterm E



120217

SN 716 Overlay



120218

Plastic Overlay For DTH /ITH /DTR /ITR 8-Button Display Phone

PLASTIC OVERLAY



120219

Plastic Overlay For DTH /ITH /DTR /ITR 16-Button Display Phone



120222

Plastic Cover for DTH/ITH/DTR/



120224

Series E 8 Plastic Overlay



120225

Series E 32D Plastic Overlay



120226

Series III, ETW/ETJ 16DC Plastic Overlay



120227

Series III, ETW/ETJ 16DD Plastic Overlay

HANDSET



121401-01

Series I ETT Handset



121402-

Series II ETE Handset

01 03



121403-

Series III ETJ / ETW Handset

03 09



121404-

Series E DTP /DTU Handset

02 09



121405-

Series I DTH/DTR

02 09



121407-03

NEC DTL700/300 Handset



121422-01

Series II ETE Handset

BUTTON/KEY



120301-

LCD Function Key for Series E

0204



120302

Series II, ETE 16 Speed Dial Button(1-10), (11-20) and Line Key



120302-L

Series II, ETE 16 Line Key (8-Key), Grey Color



120302-S

Series II ETE 16 Speed Dial Button(1-10) (11-20) Grey Color



120304

Series I ETT-16-1 Speed Dial Button and Line Key



120304-L

Series I ETT-16-1 Line Key (8-Key)



120304-S

Series I ETT-16-1 Speed Dial Button (5-Key) Tan Color



120305

Series II Rubber Dial Pad



120305-06

Series II ETE 6D COMP Kits. Dial Btn, Line Key Btn, Speed Dial Key



120305-16

Series II ETE 16 COMP Kits. Dial Btn, Line Key Btn, Speed Dial Key



120306

LCD Function Key for Series i



120307

Series II ETE 6D Speed Dial Button and Line Key Grey Color



120307-L

Series II ETE 6D Line Key Grey Color



120307-S

Series II ETE 6D Speed Dial Button Grey Color



120309-

Series E DTP/DTU Dial Button Feature Button and Volume Key Set

0220



120309-1

Hold Cap Key For Series E Red Color



120310-

ETJ-8-1 Volume Control Key Cap

0509



120313

Series I ETT-16 Dial Pad



120314-

Series III Button Set, Dial Button, Feature Button, Line Button

0405



120316-16

Series E Memory 16-Button Line Key

BUTTON & KEY



120316-32

Series E, Memory Line Key
32-Button



120316-8

Series E Memory 8-Button
Line Key



120317

SN716 Button Set Feature
Button Line Button Volume
Control Key

WALL MOUNT CLIP



121803-

Series III Wall Mount Clip
0209



121804-

Series E Wall Mount Clip
0209



121805-

Series I Wall Mount Clip
0209

STAND & HOUSING



120401-

Outer Base for DTP-8-1 /
DTP-16-1
0207



120402-

Stand for DTP-32D/ DTU-
32D
0209



120403-

Stand for
DTP-8-1/ DTP-16-1
0207



120404-

Series III (ETJ /ETW) Wall
Mount
0309



120405-02

Series I Stand



121701

Series III Leg for Stand
020309



121702

Series II Rubber Feet



121703

Rubber Feet for Series III

STAND & HOUSING



121704
Series E Rubber Feet



121705
Rubber Feet for Series I
Outer Stand Color



121706
Clip For Series I Outer Stand
Color: Black



120501
Housing Set for PSIII

LCD & LCD CASE



120601
Series I ITR/DTH LCD Case

COMPONENTS



122403-
Series III ETJ/ETW Handset
Clip 0309



122404-
Series E DTP/DTH Handset
Clip 0209



122405-
DTR/DTH Series I Handset
Clips 0209

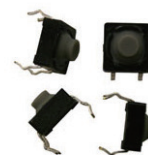

122701
DTR/DTH Series I Micro
Switch



122702-02
DTR/DTH Series I Hook
Switch



111206-02
Two Prong Adapter for
Console Unit



121101
NEC IP Power Supply



120701
LCD Lens for PSIII

COMPONENTS



123001

Battery for PSIII



122704

Antenna for PSIII



121001

Mylar for PSIII, NEC



NEC

COMPONENTS



240101-

Desi Paper for
VB-44223A(B)

02 03

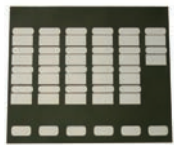

240102-

Desi Paper for
VB43223 / 43220 / 43221

02 03

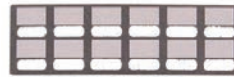

240103-

Desi Paper for
VB-43225(G)

02 03



240104-

Desi Paper
VB-44223 / 44220(G)

02 03



240105-

Desi Paper
VB-44225(G)

02 03



240106-

Desi Paper for
VB-41200(G)

02 03



240107-

Desi Paper for
VB-44210(B)

02 03

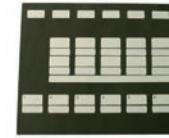

240108-

Desi Paper for
VB-42211(G)

02 03



240109-

Desi Paper for
VB-44210A(B)

02 03



240110-

Desi Paper for
VB-43233(G)

02 03



240111-

Desi Paper for
VB-44233(G)



240112

Desi Paper for
VB44320

02 03



240201

Plastic Overlay for
VB-44223A / VB-44220A



240202

Plastic Overlay for VB-
43223 / 43220 / 43221



240203

Plastic Overlay for
VB-43225



240204

Plastic Overlay for
VB-44223 / 44220

PANASONIC

COMPONENTS

PANASONIC



240205
Plastic Overlay for
VB-44225



240206
Plastic Overlay for
VB41200



240207
Plastic Overlay for
VB-44210



240208
Plastic Overlay for VB42211
/ 42210 /



240209
Plastic Overlay for
VB44210A



240210
Plastic Overlay for VB43233
/ 43230 / 43231



240211
Plastic Overlay for
VB44233



240212
Plastic Overlay for VB44320
0206



241401-
KXT Handset
0204



241402-
DBS Handset



241403-06
7200/7400 Series
Handset



241404-03
KXT 7600 Handset



241405-03
KXT 7700 Handset

COMPONENTS

TOSHIBA



140101
2010 Desi Paper



140102
2020 Desi Paper



140103
6510 Desi Paper



140104
6520 Desi Paper

COMPONENTS

NEW



140105

3010 Desi Paper



140106

3020 Desi Paper



140107

Directory Sheet



140108

Desi Paper for 5010

NEW



140109

Desi Paper for 5020



140201

2010 Plastic Overlay



140202

2020 Plastic Overlay



140203

6510 Plastic Overlay

NEW



140204

6520 Plastic Overlay



140205

3010 Plastic Overlay



140206

3020 Plastic Overlay



140208

5010 Plastic Overlay

NEW



140209

5020 Plastic Overlay



140701-03

LCD Lens for
2000 Series



140501-03

Top Housing for
DKT 2010H/2010S/
2020H/2020S



140502-03

DKT 2010SD /2020SD Top
Housing



140503-03

DKT Bottom Housing For
2000 Series



141401-

TOSHIBA Handset for
6500/2000 Series **03 08**



141403-03

3000 Series Handset



141405-02

5000 Series Handset

COMPONENTS



140401-03
Directory Tray Plastic & Paper



141701
Switch

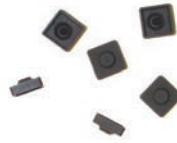

141702
Rubber Switch Cover

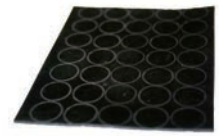

141703
Rubber Foot



141704
Rubber Feet 2000/6500 Series Square



140330
TOSHIBA 3000 Buttons, Two-Tone

NEW

COMPONENTS



161401-01
GLX Electret Handset



161401-03
AXXESS/ESP GLX Plus Electret Handset



161402-01
GLX /PHX, Dynamic



161402-03
IMX/ESP Dynamic



161402-18
DVK, Dynamic



160401
Stand for AXXESS

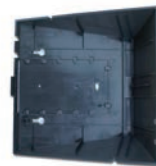

160403
Stand for Premier 24 Button



160202
Plastic Overlay for ESP / IMX Ext Window



160204
AXXESS Direct Tray W/Sheet



160208
Premier 8 Button Desi Plastic



160212
IMX/ESP 12 Button Desi Plastic



160224
Premier 24 Button Desi Plastic

COMPONENTS



160301

White Button Cap For ESP / IMX Phone



160302

Wall Clips For AXCESS 100 Units Per Pack



160303-

GLX 4200/4300 Standard Dial Button set **0918**



160311

AXCESS Button 12 Per Set

COMPONENTS



170301-

EXECUTONE M-Series Dial Button **0204**

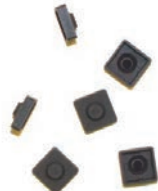

170302

IDS Soft Button Cover



170303-1

IDS Long Button Cap For 29 Key



170303-2

IDS Small Button Cap For 29 Key



170303-3

ISOETEC Post Cops



170304-

M-Series Feature Button **0204**



170305-

M-Series Line Key **0204**



170202

M-Series Ext Window

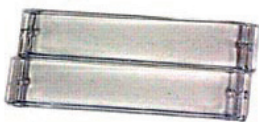

170203

105 CX Clear Flip, Desi Window

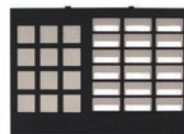

170203-

M-Series Plastic overlay for M18 /32 /64 **0204**



170204-16

M-32 Top Cap



170205-16

M-32 Bottom Cap

HANDSET



171401-02
M-Series Handset
02 03



171403-06
IDS K-style Handset

COMPONENTS



251401-03
SAMSUNG DCS Handset

COMPONENTS

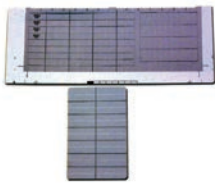

130101
Desi Paper For Comdial
6414/6614



130201
COMDIAL 6414/6614 Desi
Strip / Window



130202
COMDIAL 3500 Series Short
Desi Strip



130203
COMDIAL 3500 Series X
Long Desi Strip



130212
Impact 8012S/8112S
Plastic



130224
Impact 8024/8124



130301
Comdial Rubber Dial Pad for
7700 Phone



130701-02
Comdial Impression LCD
Lens, Also Works For
Comdial Unison Phones

COMPONENTS



130112

Impact 8012S/8122S
Selectset 720/730



130124

Impact 8024/8124



131401-

Comdial Impact handset

02 04



131402-

Handset for Comdial
7714/6414

01 02

COMDIAL

COMPONENTS



310112

Paper For DT 12



310112-D

Desi Paper for DT12D



310124

Paper for DT 24



310212

Faceplate for DT 12



310224

Faceplate for DT 24

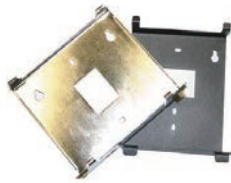

310401

FT Wall Mount Kits



310402

DT Wall Mount Kits



311401-

Handset for DT / CT / DS
Series

02 10

FUJITSU

COMPONENTS



181401-08

Starplus 1400-08 Color: Off
White



181402-54

Starplus SP61600-54



180301-

VODAVI 150 Rubber Dial Pad

02 04

VODAVI

COMPONENTS



191401-
Handset for TIE ONYX
88360 / 88361 / 88363
02 07 08



190701-02
TIE, DELPHI Lens



190702
Lens for Tie Buscom Plus
Phone



190303
Tie Delphi / Econo Key Cap

COMPONENTS



290601-03
LCD Display Case
Color:Charcoal

COMPONENTS



300401
I(i) Series 92830 Stand
Color:smoke



300701
I (i) Series Display Cover,
Color:Charcoal



300702
I(i) Series Display Len Color:
Charcoal



301401-02
I(i) Series 92XXX K-style
Handset

COMPONENTS



620401
SHORTEL 530/560 Stand



620402
SHORTEL 230 Stand



620403
SHORTEL BB24 Stand



621401-02
SHORTEL Handset, Black

COMPONENTS



271401-22

Siemens Optiset Handset, Pearl Grey



271402-02

ROLM 300 / 600 Handset, Black



270210-01

ROLM Plastic Clip

ROLM

COMPONENTS



150402-

Stand For PROSTAR 824 Color: Black-02 Almond-07



151401-

PROSTAR Handset Color: Black-02 Almond-11

PROSTAR

COMPONENTS



321402-04

Mitel 4XXX Handset



321101

Mitel Power Supply INPUT: 120V, AC 60Hz 33.5W; OUTPUT: 12V, 1667mA

MITEL

Handset Cords



HCAS0207
HCAS0212
HCAS0225
HCBK0107
HCBK0112
HCBK0125

Ash02 7Ft
Ash02 12Ft
Ash02 25Ft
Black01 7Ft
Black01 12Ft
Black01 25Ft

Line Cords



LC4C07
LC4C07BK
LC4C14
LC4C14AS
LC4C14BK
LC4C25
LC4C25BK
LC4C25IV

4Pin 7Ft
4Pin 7Ft, Black
4Pin 14Ft
4Pin 14Ft, Ash
4Pin 14Ft, Black
4Pin 25Ft
4Pin 25Ft, Black
4Pin 25Ft, Ivory

PHONE CORDS

COMPONENT



611101

Polycom Power Supply
Works on 320 / 330 / 430
/ 550 / 560 / 601 / 650 /
670
Input: 100-120V AC / 0.6A
Output: 24V DC / 500mA
Polycom
Model: SPS-12-015-240
P/N: 1465-42340-001



610401

Stand for Soundpoint IP
430, Black



611103

Power Supply Kit for
SoundStation Conference
Unit



611102

Polycom Power Supply
Works on SoundPoint IP 301
& IP 501
Input: 100-120V AC / 0.6A
Output: 12V DC / 1000mA
Polycom Model: SPS-12-
009-120
P/N: 1465-42423-001



610402

Stand for Soundpoint IP
501, BLACK

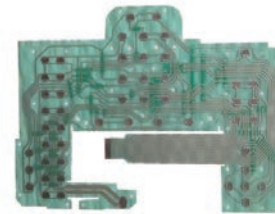

611001

POLYCOM Mylar
Soundpoint 501



470501

Housing Set For 8440
Phone (Top With Blue
Faceplate, Clear Pipe,
Bottom, Battery Clip)



470502

Housing Set For 8440
Phone (Top With Black
Faceplate, Clear Pipe,
Bottom, Battery Clip)



470301

Dial Button For 8440 Phone



470701

Blue Faceplate For 8440
Phone

470702

Black Faceplate For 8440
Phone



Address: 4403 Greenbriar Drive, Stafford, TX 77477

Phone: 800-838-5070(Toll Free), 281-491-5990

Fax: 800-852-5338(Toll Free), 281-491-5991

Web: www.dvd-inc.com

Email: info@dvd-inc.com